



MikroTik Powered Routers an Elegant Solution



Venue: MUM Europe 2009
Date: 27th Feb 2009
Speaker: Tom Smyth
CTO Wireless Connect Ltd.



Wireless Connect Ltd.

- Based in and operating out of Ireland
- MikroTik Distributor
- MikroTik Collaborator
- MikroTik Training Partner
- MikroTik OEM Partner



Ogma Connect

- A Collaborative Effort involved in the development and support of MikroTik Powered Appliances
- Ogma Connect's name comes from the Ancient God of Communications and eloquence who's name was Oghma
- Oghma was credited with the was credited with the invention of the written language Ogham which is found carved in stones that mark ancient tribes throughout the once vast Celtic world in northern & western Europe
- We want people to be able to connect with each other by communicating eloquently



Aims

- Discuss assessing your Network Hardware requirements
- Outline items to consider when procuring hardware
- Outline steps involved in assembling hardware
- List important issues that affect choice of network platform
- Present some hardware solutions provided by Wireless Connect
- Outline a tough approach to testing hardware appliances
- Outline how some of MikroTik's & Wireless Connects products stand-up to these tests



Hardware Selection Criteria

What products can offer redundancy

Site / Power / Device / Interface

What is the Cost of the Equipment

Installation /initial cost

Ongoing maintenance /running cost

Environmental initiatives green data centre

Government backed Green data centre financial incentives

Electrical Cost of running the equipment

Cost of cooling the equipment

What is Business Uptime / SLA Requirement in terms of:

How many users are likely to be affected by outages / failures (taking future expansion into account)?

How much revenue can be generated by offering higher uptime guarantees?

How much financial penalties would be incurred in system failure?



Hardware Selection Criteria

- What performance is required ?
 - How much throughput is required through the box?
 - How many concurrent connections are to be supported?
 - What is the Encryption Throughput requirements?
 - What is the Firewall Requirements?
 - What is the latency tolerance of your network applications?



Looking for Answers / Solutions

- Ask a vendor about what they have to offer you
 - Ask about lead times
 - Ask about support options
 - Ask about warranties
- Learn from the free advice that they offer you



How Expensive is a Failure

- Lost Reputation
- Lost Customers
- Financial Penalties
- Cost of Failures >> Cost a well designed, manufactured, tested & deployed Router



Choose Processors

- Clock Speed
- Operations per Cycle
- L2& L3 Cache
- FSB...
- Memory technology supported





Choose Processor

- AMD Opteron
- Intel Xeon
- AMD 64 Processor
- Intel Core 2 Duo
- P4/ Athlon XP
- PIII/ Athlon
- Atom/ VIA C3/C7
- Geode

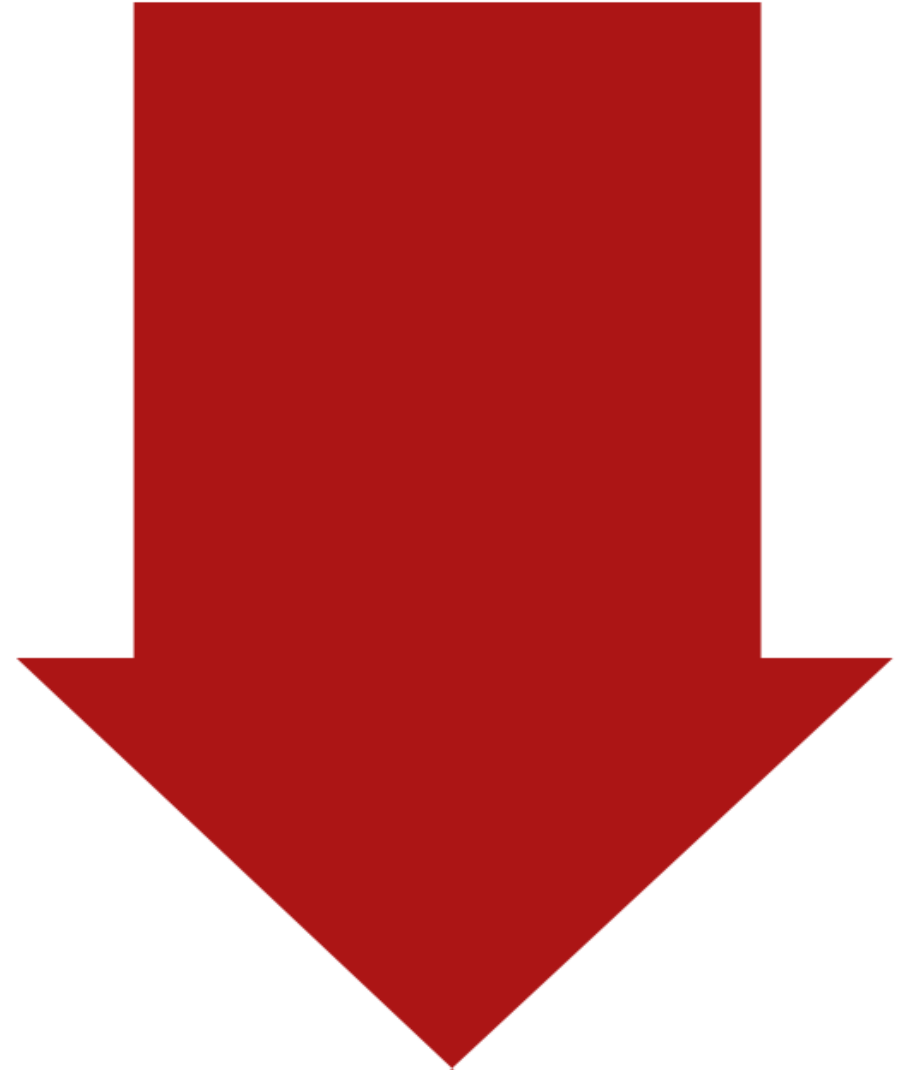



Choose RAM

- Related to FSB
- Faster Better
- Fully Buffered Dimms/ INtel 5xxxx Processors
- DDR2 667+ RAM
- Dual Channel RAM
 - Install Matched pairs of ram
 - Install pairs of pairs (servers) multi CPU
- ECC (Error Correction Code)
 - Higher Cost More Reliable

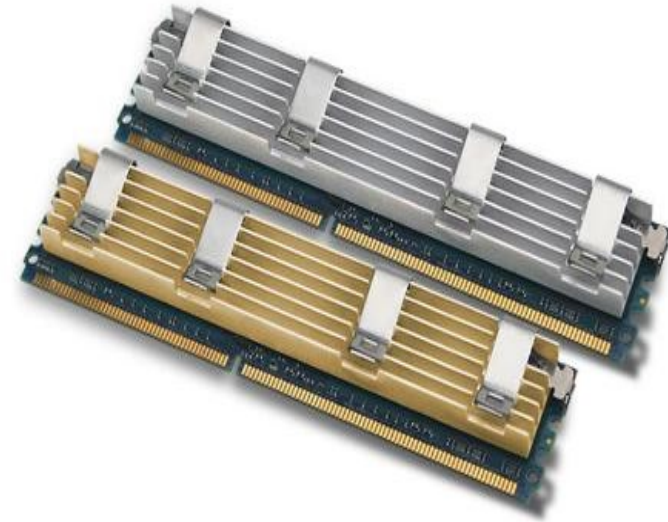



Choose Main Board

- Reputable Server boards
 - Watch Storage Controller
- check chipset / bios features
- Implemented chipset features
- Chipset is compatible with your RAM/Processor Choice
- Integrated Network Interfaces
- Console Redirection
- Remote management systems
 - Ipmi etc

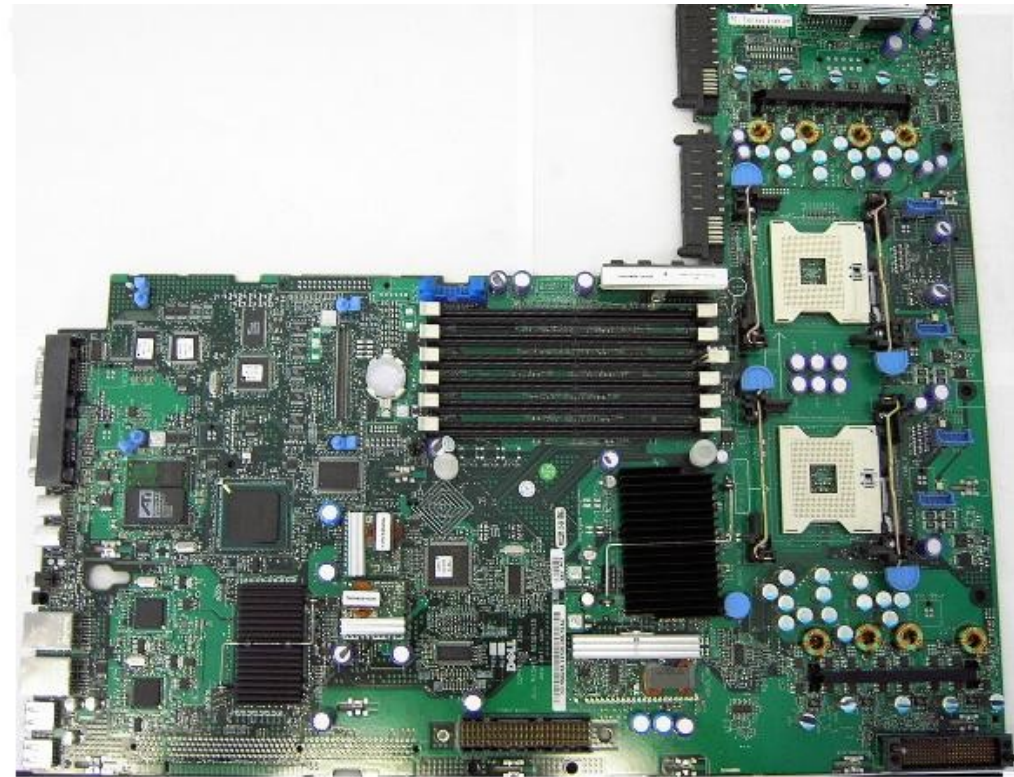



Choose Main board

- PCI Express (multi Lane)
 - PCI Express Switches multiple Lanes reducing contention
- PCI Busses (watch contention)
- Multiple PCI buses with contention reduction
- Bandwidth.. PCI-x
-

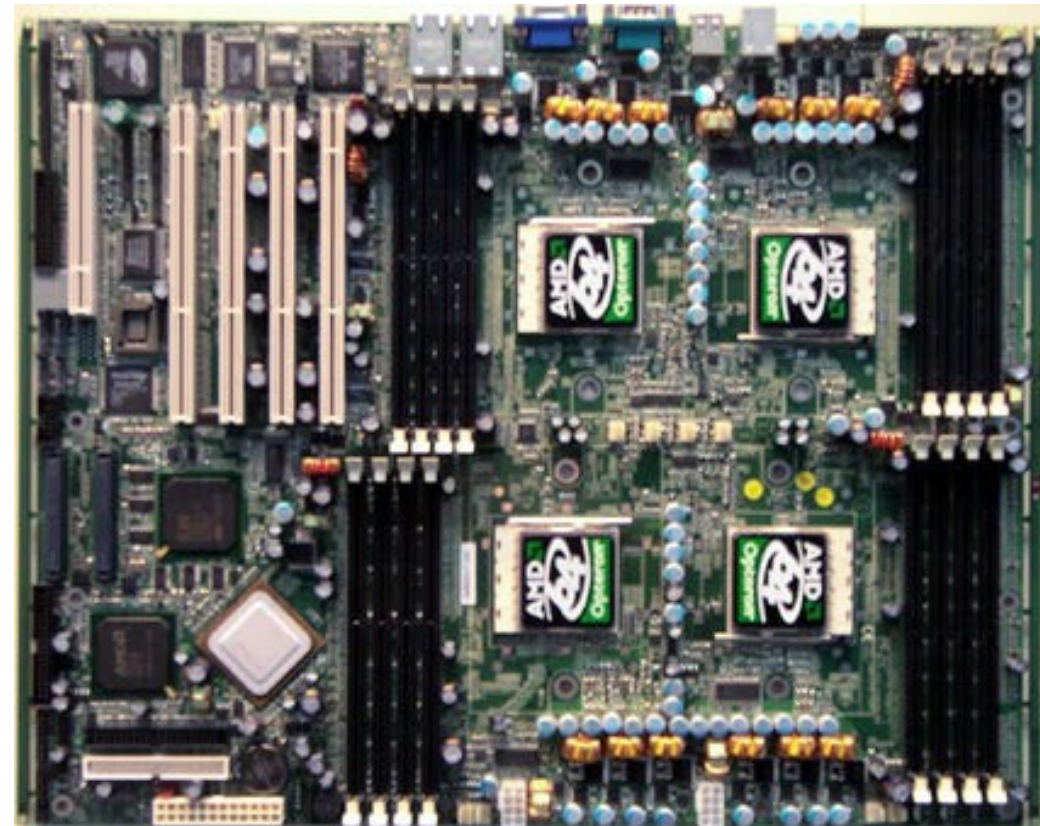



Choose main board

- What network hardware are you going to use
- SDSL Cards... PCI /PCI-x
- RB44G/V ..PCI/ PCI-x
- Multi port Gigabit Net Cards (Intel/Broadcom) PCI- E /PCI X
- Number of Interfaces Required (Head Room)
- No of PCI E Lanes /PCI Bus master interfaces

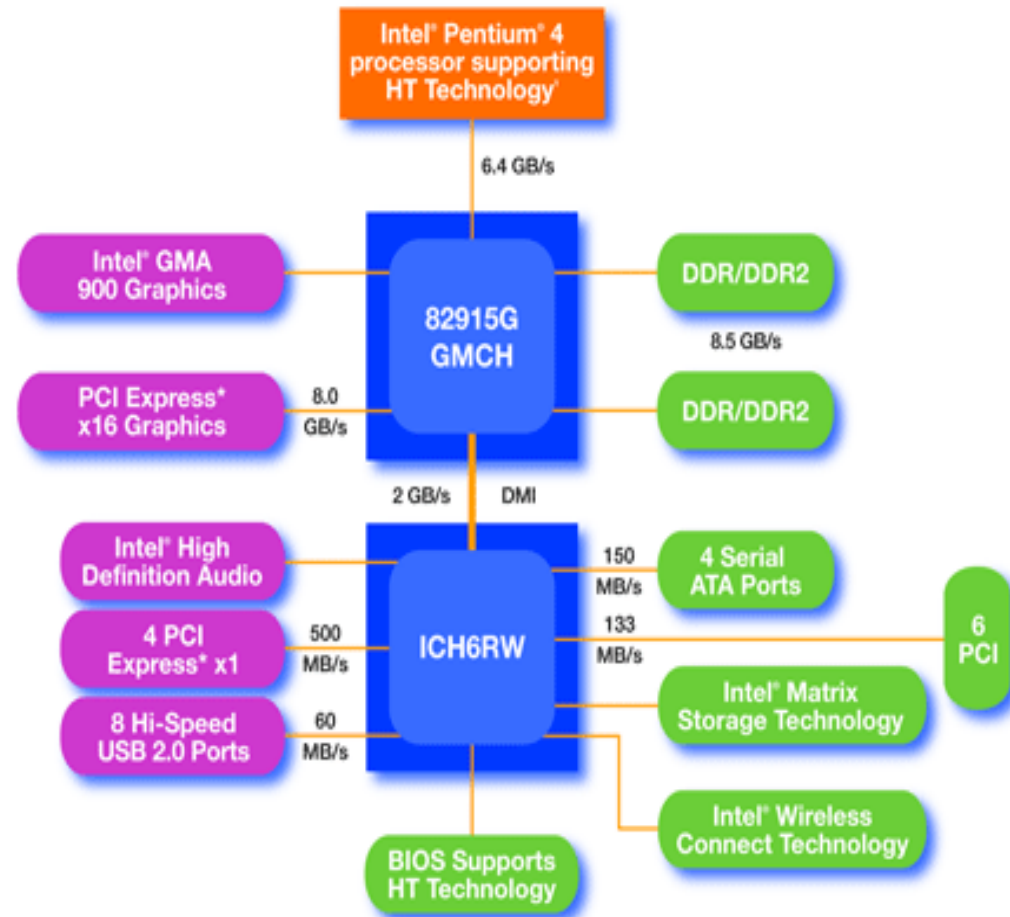



Choose Disk Types

- Magnetic Disks (RPM)
- Solid State Disks
- FLASH
- RAID
- Combination



Magnetic disks

- Fast RPM (Low Latency)
- Proxy Requirements
- 10000RPM SATAII
- 15KRPM SAS (need Virtualization Layer to Emulate simple Disk Subsystem)
- RAID (Virtualization)
- Prone to Vibration





Flash Drives

- Limited Life expectancy
- Speed
 - Ensure that speed is sufficient
 - Flash speeds vary
- Ensure High Quality
 - Military Grade
 - ECC
 - Write Management



Solid State Drives

- New Technology
- Vibration Resistant
- Fast
- Lower power consumption
- Expensive



Chassis / Cooling Redundant Fans

- Rackmount
- Environmental?
- AirFlow
- Cost of “U” Space
- Dimensional Limitations



PSU

- Sufficient Power
- Power Wastage
- Green Data Centre
- MTBF
- Redundancy considerations
- Make Sure Sufficient Current Supply on all Voltage Rails



Assembly Best practices

- Grounded workbench
- ESD precautions
- Screw Main board using all available mounting holes.
- Route / tie cables to avoid fans & blocking air flow
- Use correct settings for Main board FSB speeds & CPU Speeds
- Test test, test, test, test, test test
- And burn in test again before putting into production



Selecting appliances

- Assess Platform Speed
- Value for Money
- Support Contract
- MikroTik Support
- Head Room -> Scalability



Future of Networking

- 64 Bit Support from MikroTik?
- ASIC Support ...AES VPN accelerators
- FPGA(programmable Chips) Offload
- TCPIP Off Load Engines
- Use GPUs for Tough tasks
- Multi Core Simulti-Tasking



64 Bit Support

- More Memory Access for Xen Vms ... More Scalability
- Faster Processing of AES 256 Bit Encryption (typically 2-4 times faster than equivalent 32 bit processes)
- 16x 128 bit vs 8x 128 bit SSE2 Registers
- Compression Performance can be increased also

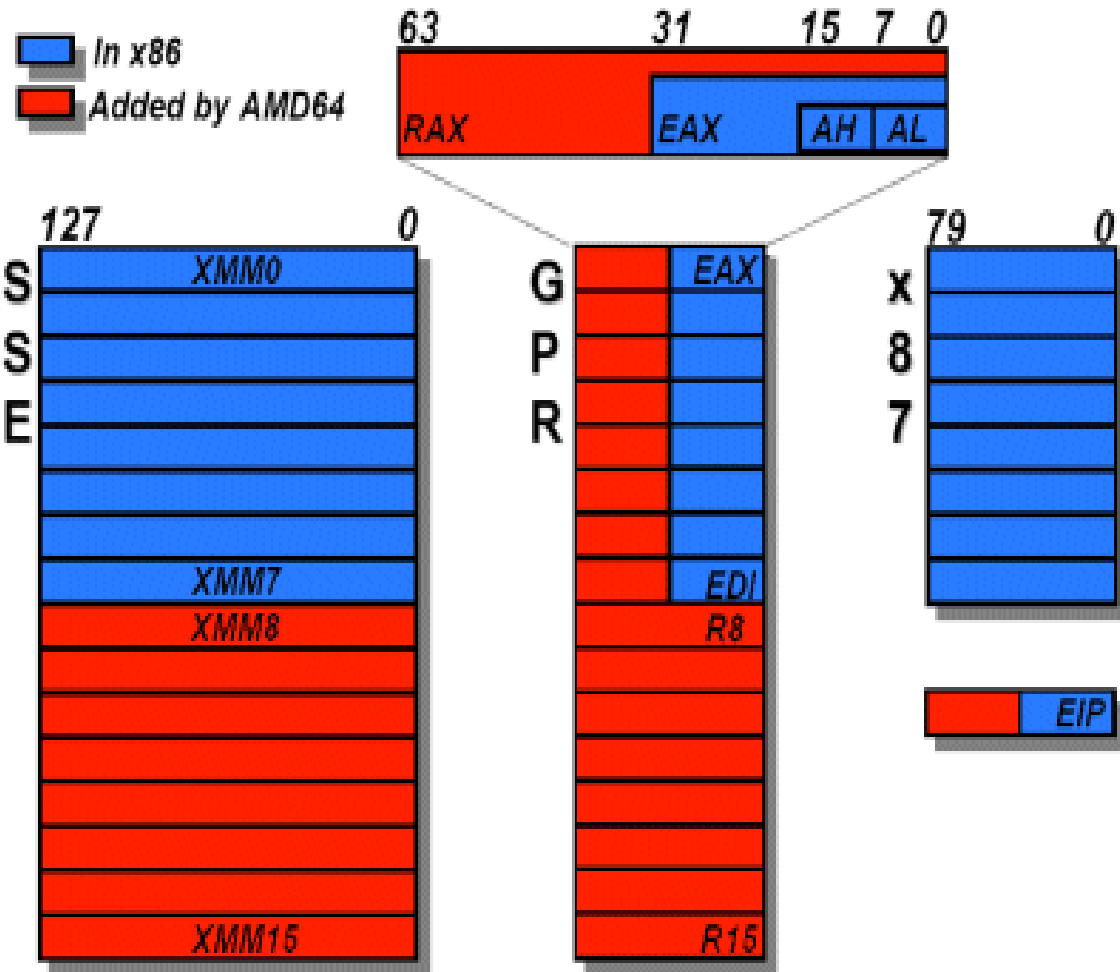



ASICs

- Application Specific Integrated circuits
- Fast processing of complex tasks such as compression /encryption
- Power efficient and compact
- Inflexible ... change in software can have devastating impact on performance of the chip





FPGAs

- Can implement very complex tasks... Compression / Encryption
- Programmable
- Very hard to reverse engineer
- larger chip foot print
- Bigger carbon footprint

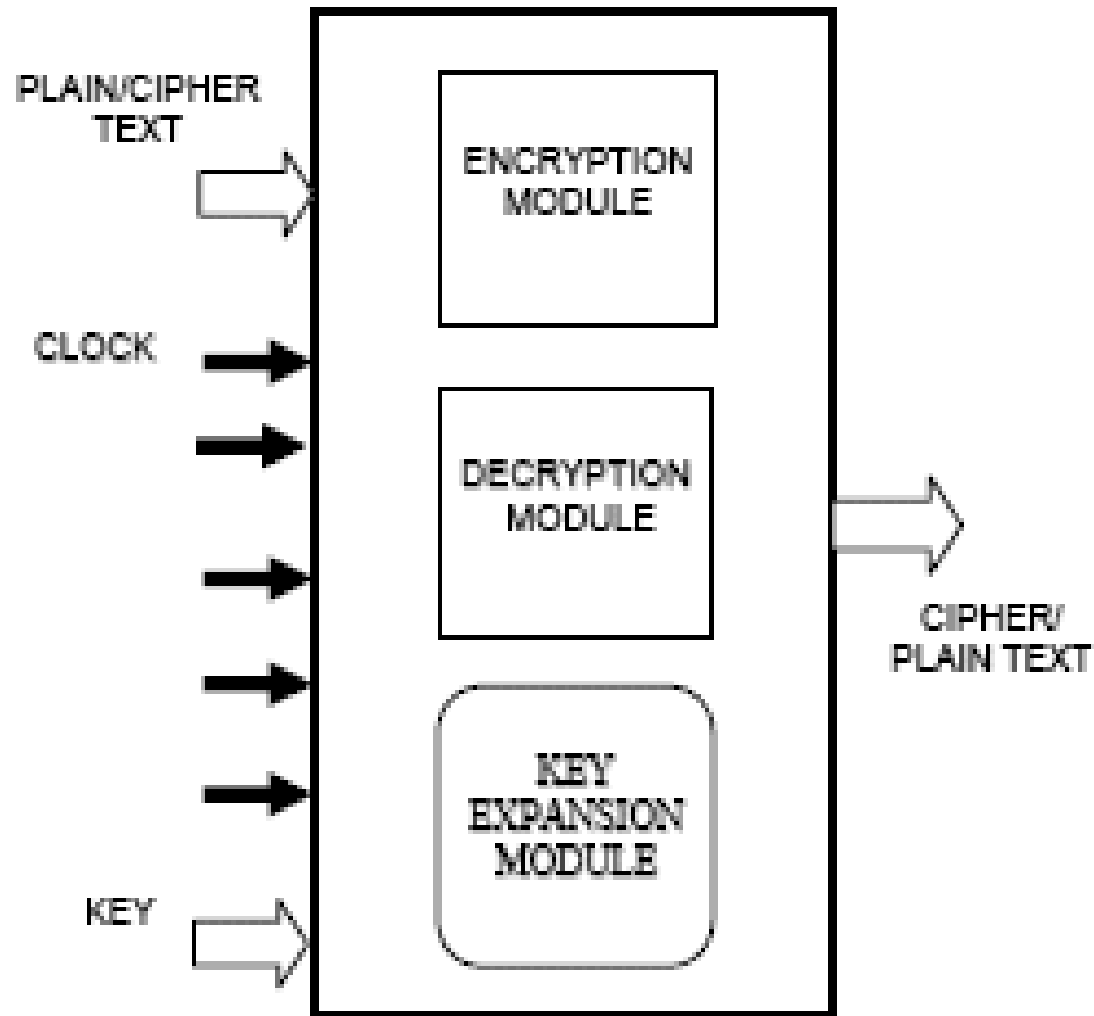



MultiCore networking

- Tasks can be distributed amongst the CPU /Cores
- Tough tasks can be broken into simpler tasks
-



Co-Processors

- FPU Floating Point processing units
- CPU off load
- Used in VPN Acceleration Products
- PPC QICC Engine :)



Recycle old computers into MikroTik Routers

- Not such a great idea
- Shred Computer
- Melt materials down to create components of your new router
- Purchase new components from your preferred vendor :)
- Purchase your Router from us :)





MikroTik Router Performance Tests

- Iperf used to test bandwidth
- Independent industry standard tool
- Developed by the American Military to test performance on their networks
- Low CPU overhead for testing systems
- Need at least 2 installations (one per each end)
- Lots of configurable options (variance in results)

Bandwidth Test

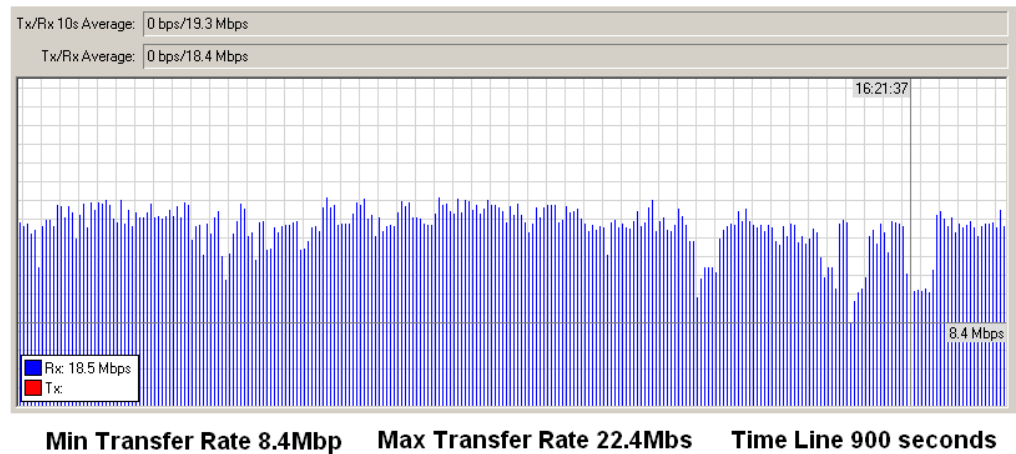



Iperf Test Setup

- 4x Dell PowerEdge 2800
- CentOS X86-64 5.2
- TCP used as is most difficult and gives a realistic assessment of Routers Real world performance
- Bi-directional simultaneous test to further test the routers
- 4 servers testing routers were used where possible
- Sustained tests
- Accuracy +/-1%



Tested Scenarios

- Routing with No Connection Tracking (Calibration)
- Routing with Contrack
- Nat firewall Src /Dst NAT
- Router -Router IPSEC
AES256bit MD5 ESP& AH
Tunnel with IPIP



TCP Routed Test

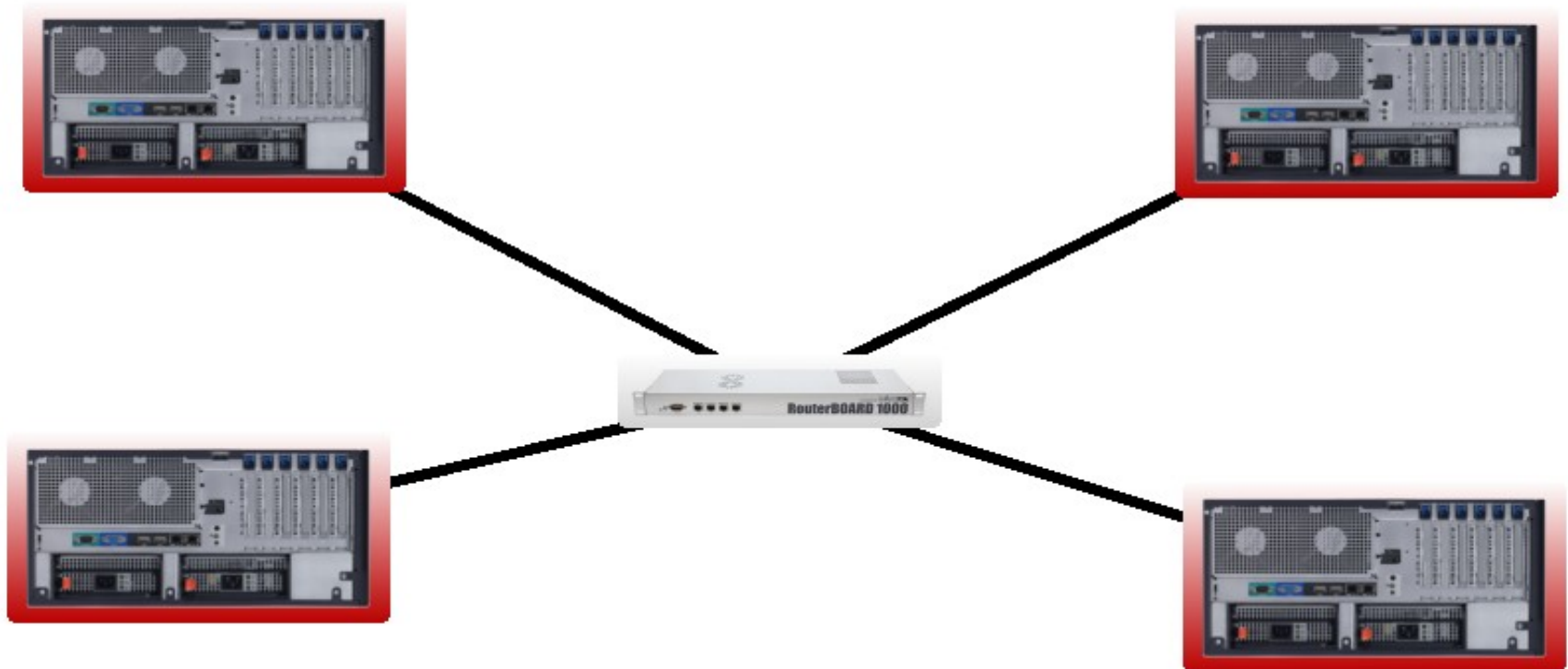



TCP Source /Destination NAT Test

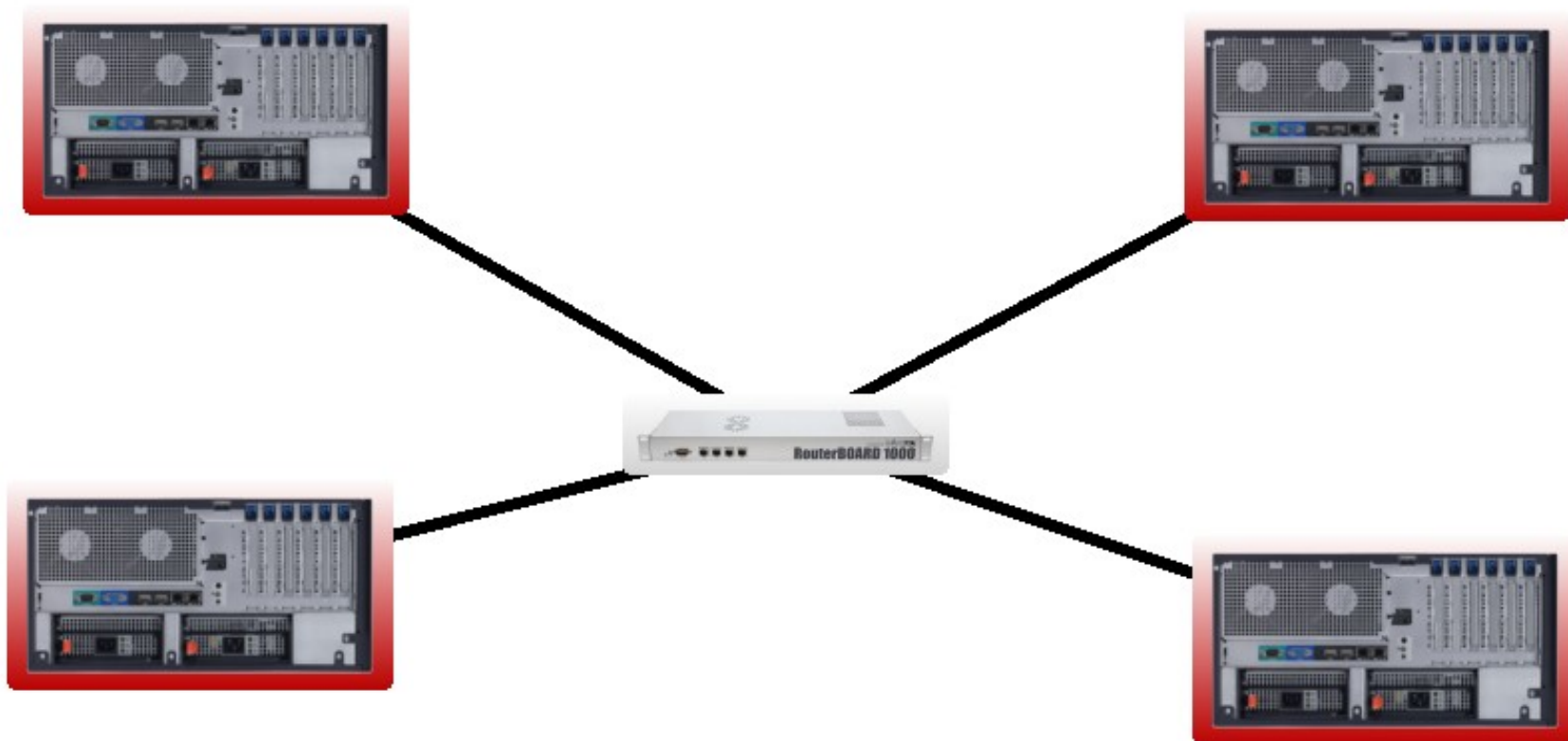



TCP Routing over IPSEC 256 bit AES MD5 IPIF

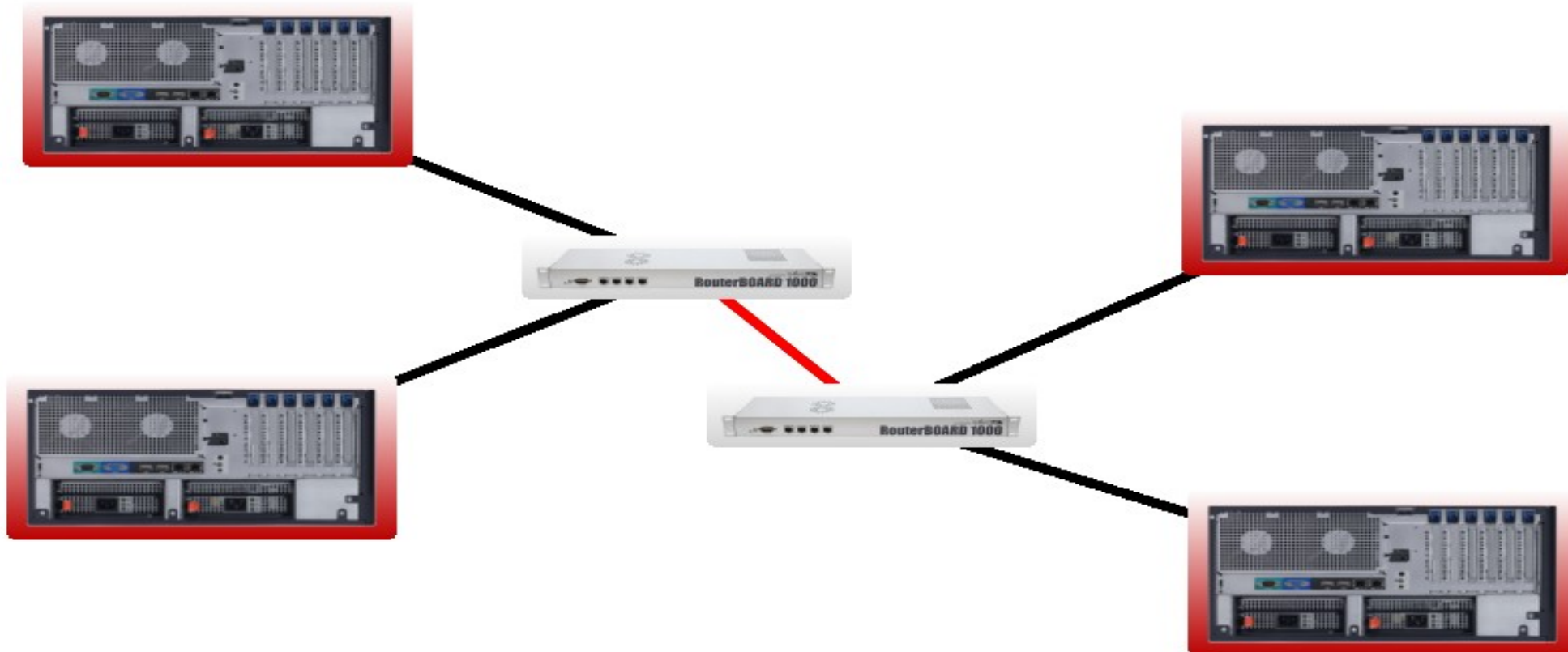



Test result variance

- Configuration differences
- Network topology
- Network Conditions...
- Latency /TCP window
- End clients
- Traffic types



MikroTik RB 1000

- PowerQUICC Security Engine
- 1.3GHz Processor
- King of
 - Packet / Throughput performance per Watt ...Green Machine
 - Packet / Throughput performance per \$/€.... Lean Machine
 -





RB1000 Results

- TCP-Routing (with Contrack on) • 1,105Mb/s (90,991P/s)
- TCP-Routing (with Contrack off) • 2099Mb/s (172,818P/s)
- TCP-Nating (SRC +DST Nat) • 906Mb/s (74,605P/s)
- IPSEC256AES AH&ESP MD5 IPIP • 125.4Mb/s (10,326P/s)
- (2x Duplex Concurrent tests)
- Excellent Enterprise Device at SOHO Price





Ogma Connect 2000

- 7 GbE interfaces By default
- Intel Multi Core processor
- Up to 11 network interfaces
- Similar to the Legendary power router 732
- Routed TCP (contract on)
Throughput of
- 2,288Mb/s (188,406 P/s)





Ogma Connect 1435U

- Dual AMD Opteron 64
- IPMI Management
- 2 interfaces by default
- Scales up to 8 interfaces
- Up to 2x 10KRPM 3.5" SATA HDD
- Virtualization / Native running mode





OgmaConnect OC1435 Results

- TCP-Routing (with Contrack on) • 2,903Mb/s (239,048P/s)
- TCP-Routing (with Contrack off) • 2,931Mb/s (241,353P/s)
- TCP-Nating (SRC +DST Nat) • 2,881Mb/s (237,236P/s)
- IPSEC256AES AH&ESP MD5 IPIP • 230.9Mb/s (19,013P/s)
- (2x Duplex Concurrent tests)
- Enterprise Device that can easily take more interfaces
- Processor can be upgraded for even better results for encryption
- Firewall Throughput excellent





OC2500 Series

- 1x CPU Intel multi Core system
- 4x Front Intel pro 1000 NICs
- 2,3,4 port Front loadable Pci E Expansion Modules
- 2port SFP Fibre Optic Transceiver module (in testing)
- 11 ports maximum available in front
- 19 ports available overall (current maximum)
- 23 ports (in testing)
- Up to 3x 2.5" SATA Disks
- 1x CF Slot





OgmaConnect 2511 Results

- TCP-Routing (with Contrack on) • 3,900Mb/s (321,146P/s)
- TCP-Routing (with Contrack off) • 3,907Mb/s (321,772P/s)
- TCP-NAT (SRC +DST Nat) • 3,661Mb/s (301,465P/s)
- IPSEC256AES AH&ESP MD5 IPIP • 349.4Mb/s (28,771P/s)
- 4x Duplex tests ... 8 ports used
- Compact appliance with up to 19/23 ports





More MikroTik Powered Routers in the Pipeline

- More Ports than ever before
- More Throughput than ever before
- More Support than ever before



Thank you!

For More Information contact

- Reseller information
- Support information
- Product information
- <http://wirelessconnect.eu>
- <http://fmsweb.de/>
- <http://mdbrazil.com.br>
- <http://ogmaconnect.com>
- <http://mikrotik.com>
- <http://iperf.sourceforge.net>