

MikroLine

- Gatot Wibowo Hamiseno.
- MikroTik Certified Trainer (2009).
- MikroLine Indonesia.

WIRELESS REPEATER in ROS 6.35

Wireless Repeater ROS 6.35

- New wireless features in ROS 6.35.
- One wireless interface can be used as:
 - a) Station and virtual station.

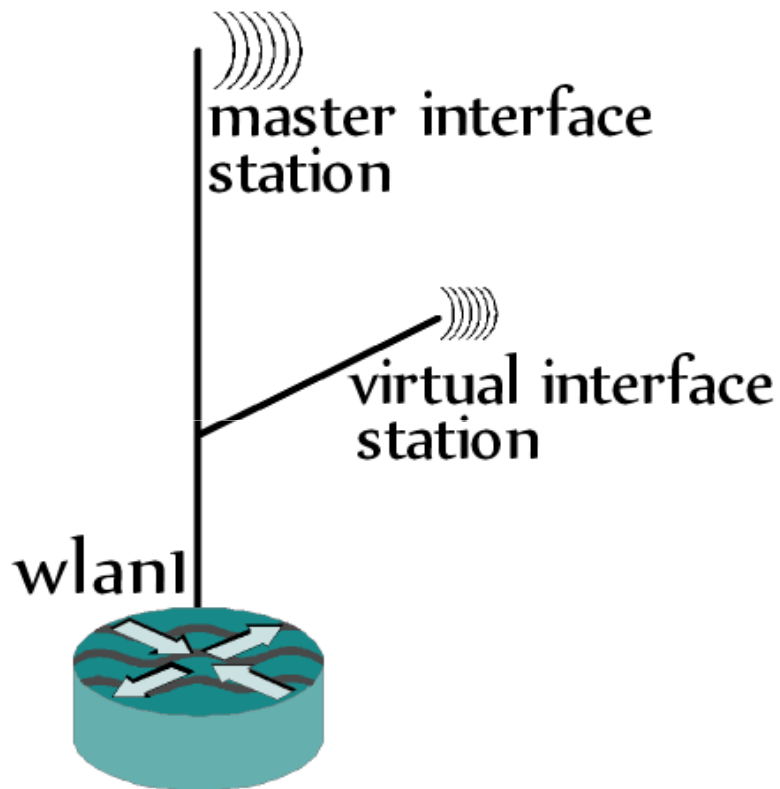

Wireless Repeater ROS 6.35

b) Station and virtual AP.

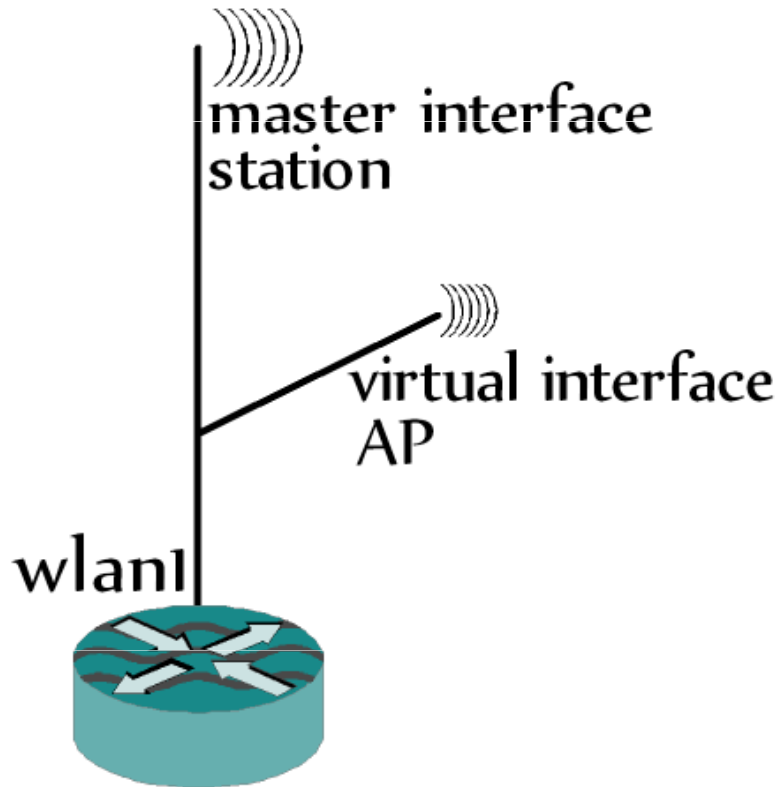

Wireless Repeater ROS 6.35

c) AP and virtual station.

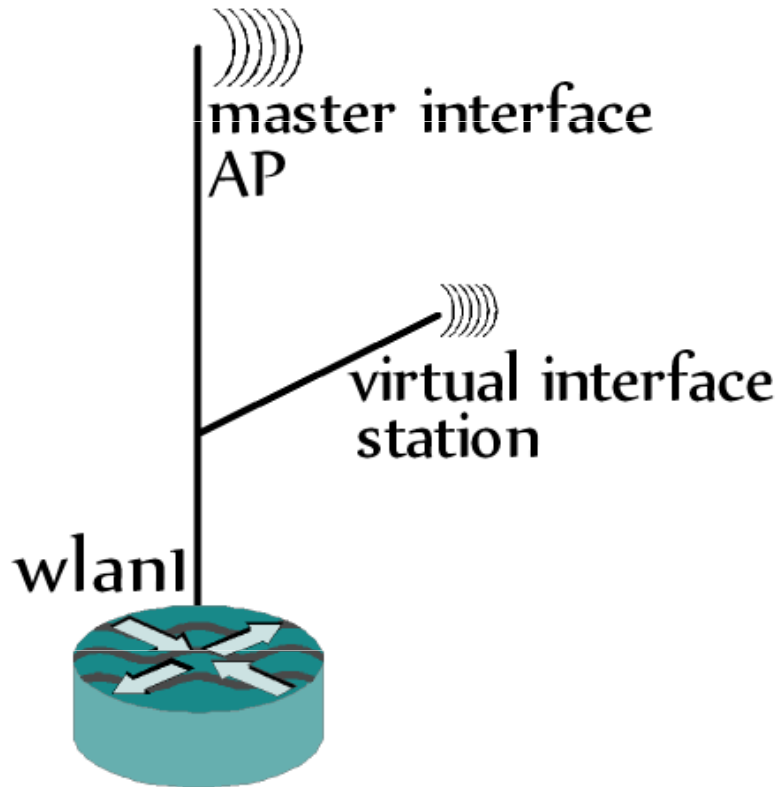

Wireless Repeater ROS 6.35

d) AP and virtual AP (since a long time ago).

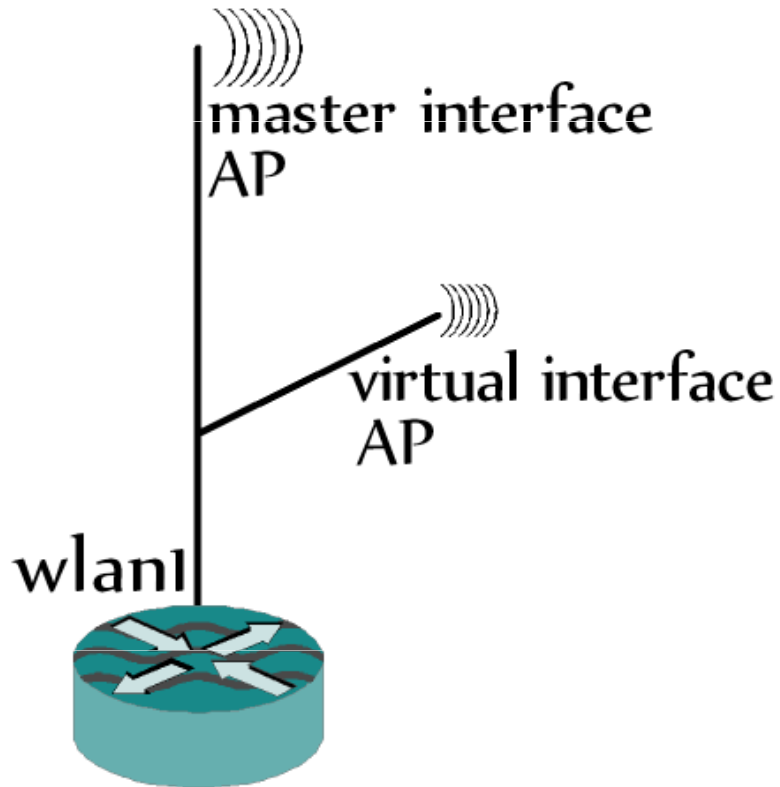

Wireless Repeater ROS 6.35

- More virtual APs and virtual stations.

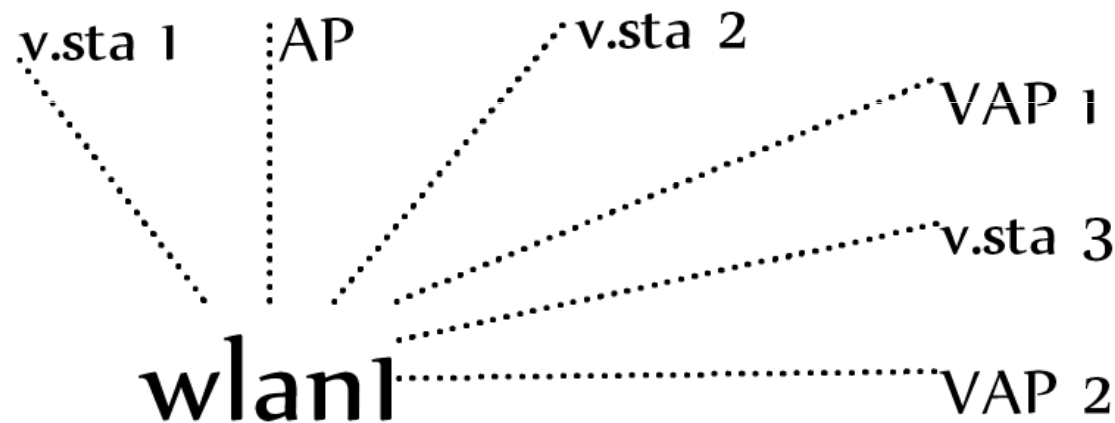

Wireless Tables									
Interfaces									
Nstreme Dual									
Access List									
Registration									
Connect List									
Security Profiles									
Channels									
+ - ✓ ✗ [Icon] CAP WPS Client Scanner Freq. Usage Alignment Wireless									
	Name	Type	MAC Address	Mode	Band	Channel...	Freq...	SSID	
R	wlan1	Wireless...	4C:5E:0C:EE:AF:0B	ap bridge	2GHz-B/G/N	20MHz	2412	AP MikroLine	
R	wlan2	Virtual	4E:5E:0C:EE:AF:0C	station bridge				ISP1	
R	wlan3	Virtual	4E:5E:0C:EE:AF:0B	station bridge				ISP2	
R	wlan4	Virtual	4E:5E:0C:EE:AF:0D	station bridge				ISP3	
R	wlan5	Virtual	4E:5E:0C:EE:AF:0E	ap bridge				AP MikroTik	
R	wlan6	Virtual	4E:5E:0C:EE:AF:0F	ap bridge				AP Training	

Wireless Repeater ROS 6.35

- Background Scan, scan AP without disconnected.

Scanner (Running)

Interface:

Background Scan

	Address	SSID	Chan...	Sign...	Noi...	Sign...	Radio Name	RouterOS Version
APRB	4C:5E:0C:6F:4...	MikroLine	2412/...	-61	0	0	4C5E0C6F4...	6.32.2

Terminal

```
84 74.125.130.100          56 45 56ms
85 74.125.130.100          56 45 57ms
86 74.125.130.100          56 45 57ms
87 74.125.130.100          56 45 57ms
88 74.125.130.100          56 45 57ms
89 74.125.130.100          56 45 57ms
90 74.125.130.100          56 45 56ms
91 74.125.130.100          56 45 57ms
92 74.125.130.100          56 45 56ms
93 74.125.130.100          56 45 56ms
94 74.125.130.100          56 45 57ms
```

Wireless Repeater ROS 6.35

- Virtual AP or virtual station must have same **band**, **frequency** and **channel width** with master interface.
- The other options can be distinguished between virtual interface and master interface.
- Virtual interface can not created under virtual interface.

Wireless Repeater ROS 6.35

- Virtual station is supported by Connect-List.
- Virtual AP is supported by Access-List.
- Virtual interface is supported by station wds mode.
- Virtual interface is not supported by wds slave mode.
- Virtual interface is not supported by nv2 & nstreme.

Wireless Repeater ROS 6.35

Install wireless-rep packet.

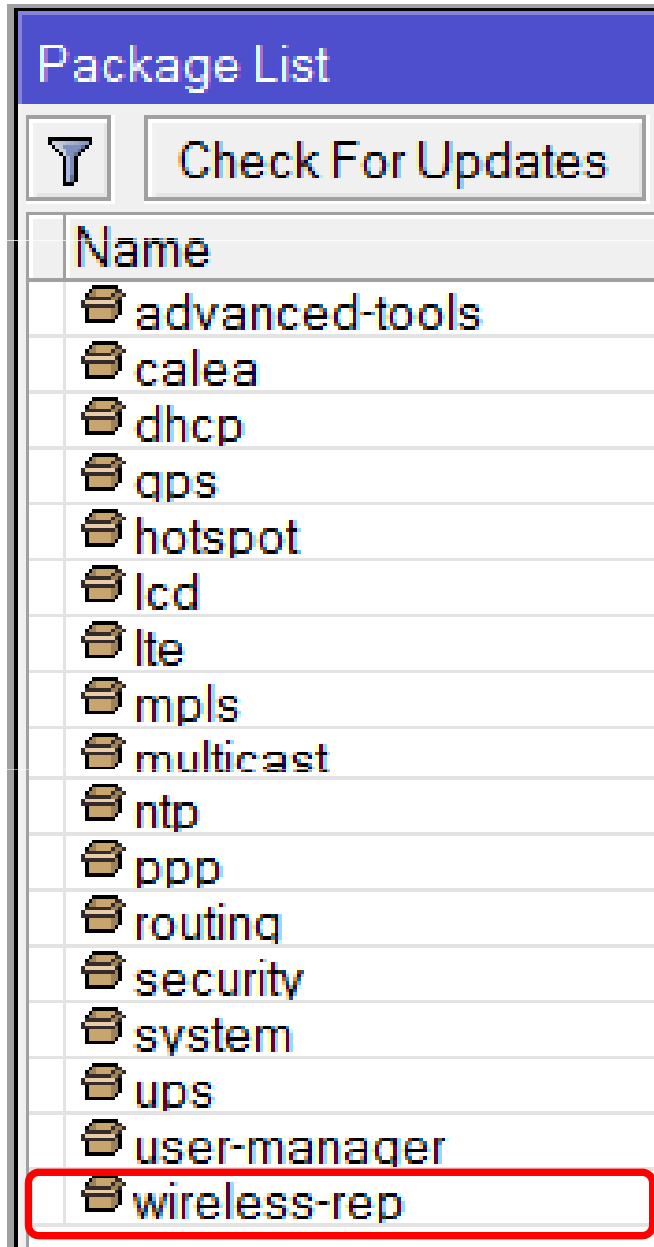

CONFIGURATION EXAMPLES

With RB951Ui-2HND

Station & Virtual Station

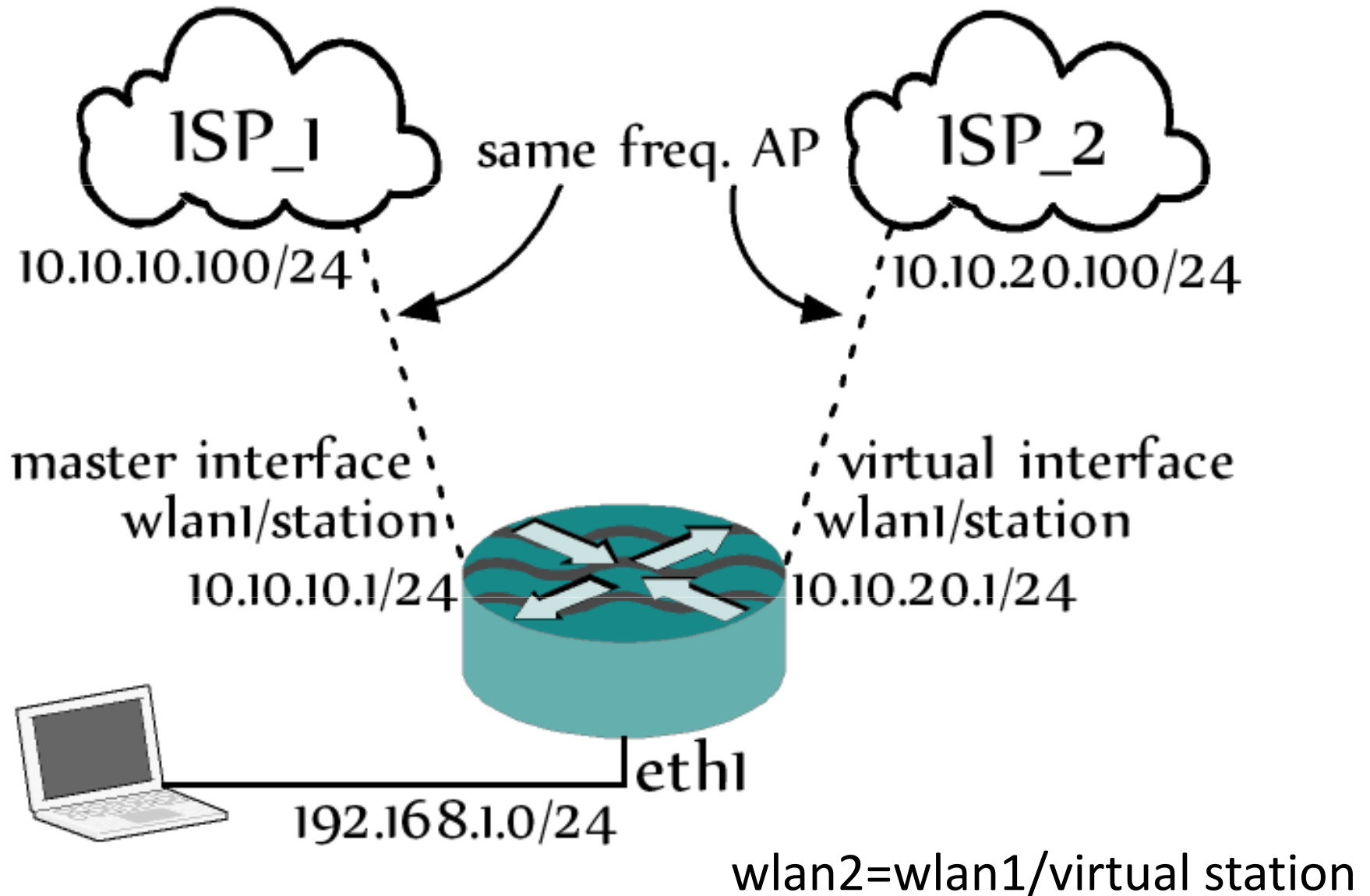

Station & Virtual Station

The screenshot shows the Mikrotik WinBox interface for configuring a wireless interface. The 'Wireless Tables' window is open, showing a table with one entry: 'wlan1' of type 'Wireless (Atheros AR9300)'. Below the table, the configuration for 'Interface <wlan1>' is shown. The 'Wireless' tab is selected, and the 'Mode' is set to 'station bridge'. The 'Band' is '2GHz-B/G/N', 'Channel Width' is '20MHz', 'Frequency' is '2427', and 'SSID' is 'ISP_1'. Red boxes highlight the 'Mode' field and the 'Band', 'Channel Width', and 'Frequency' fields. Red arrows point from text boxes to these fields.

Name	Type
wlan1	Wireless (Atheros AR9300)

Interface <wlan1>

General Wireless HT HT MCS WDS

Mode: station bridge

Band: 2GHz-B/G/N

Channel Width: 20MHz

Frequency: 2427

SSID: ISP_1

Setup wlan1 (master interface), as station bridge to connect to ISP_1.

Band, Channel Width and Frequency are also used in virtual station (wlan2).

Station & Virtual Station

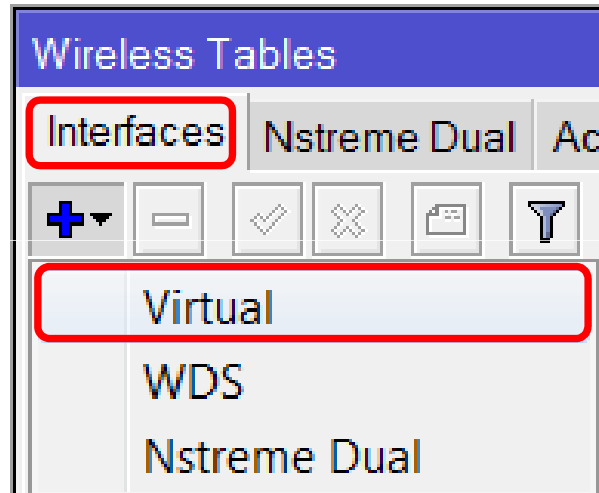

wlan2=virtual station

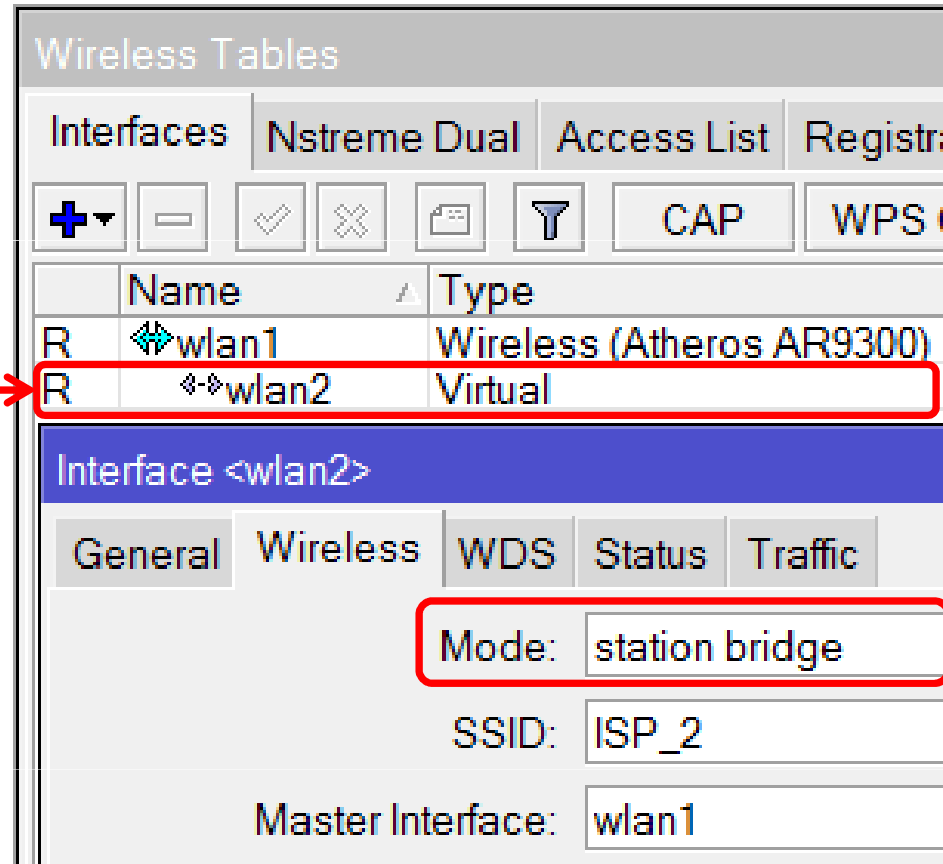

Setup wlan2 (virtual station), as station bridge to connect to ISP_2.

Station & Virtual Station

The screenshot shows the Mikrotik WinBox interface for the 'Wireless Tables' section. The 'Registration' tab is selected and highlighted with a red box. Below the tabs are several icons: a minus sign, a funnel, and a 'Reset' button. The main table displays the following data:

Radio Name	MAC Address	Interface	Uptime	AP	WDS	Last A
radio ISP 1	4C:5E:0C:13:E6:7F	wlan1	15:36:40	yes	no	
radio ISP 2	00:0C:42:61:B8:2D	wlan2	15:36:39	yes	no	

wlan1 = master interface/station.

wlan2 = virtual interface /station.

Station & Virtual AP

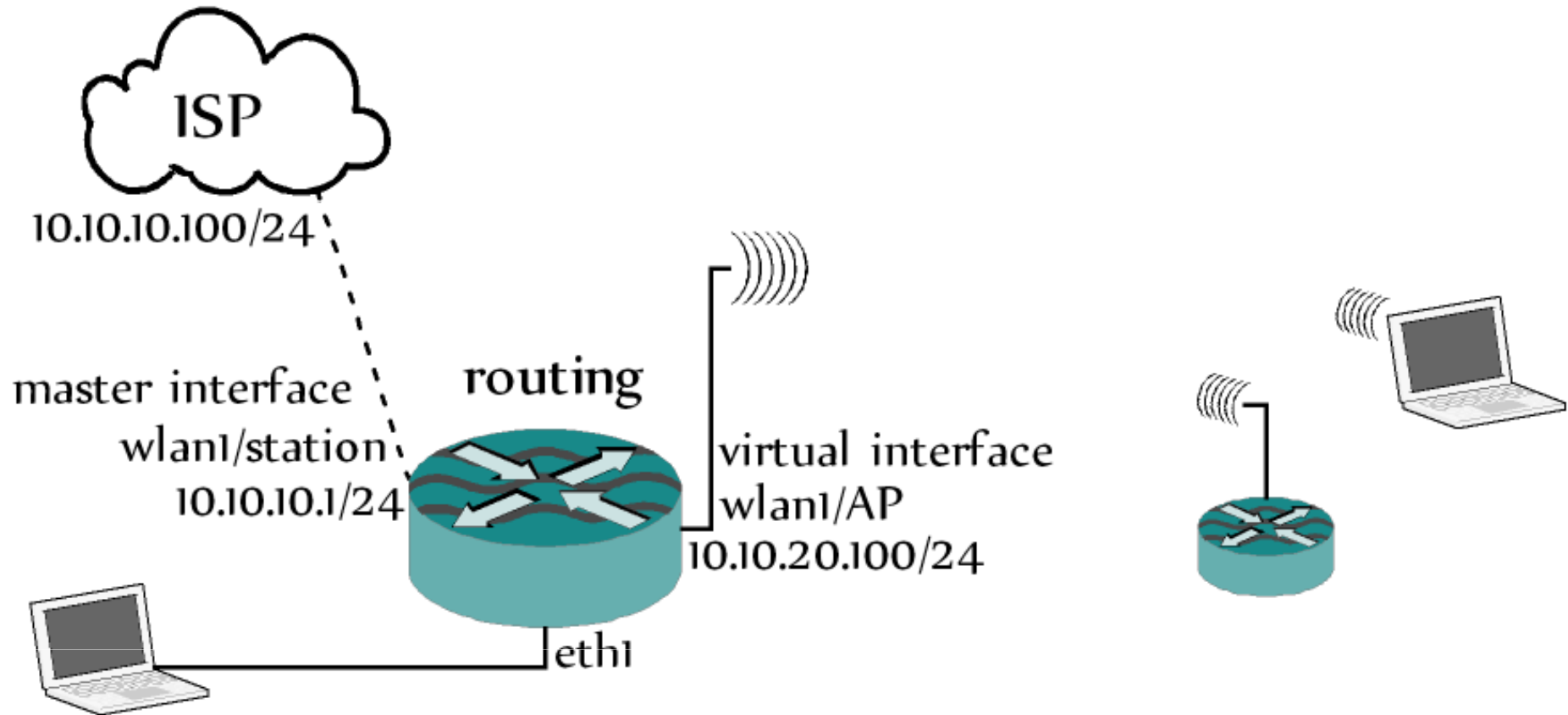

Station & Virtual AP

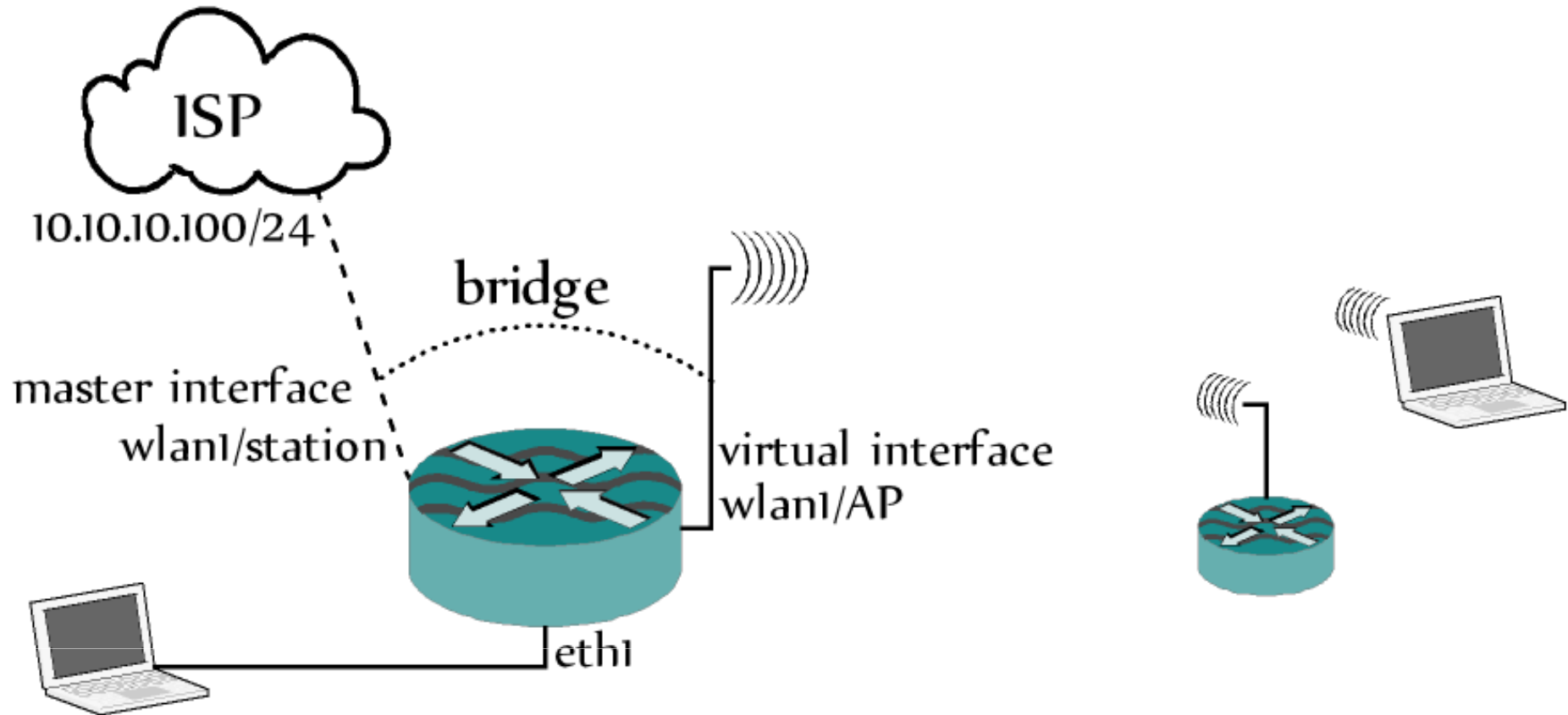

Station & Virtual AP

Wireless Tables

Interfaces Nstream Dual Access List Regist

+ - ✓ ✗ [icon] CAP WPS

Name	Type	Tx
wlan1	Wireless (Atheros AR9300)	

Interface <wlan1>

General Wireless Data Rates Advanced

Mode: station bridge

Band: 2GHz-B/G/N

Channel Width: 20MHz

Frequency: 2412

SSID: ISP

Radio Name: to_ISP

Scan List: default

Setup wlan1 (master interface), as station bridge to connect to ISP.

Band, Channel Width and Frequency are also used in virtual AP.

Station & Virtual AP

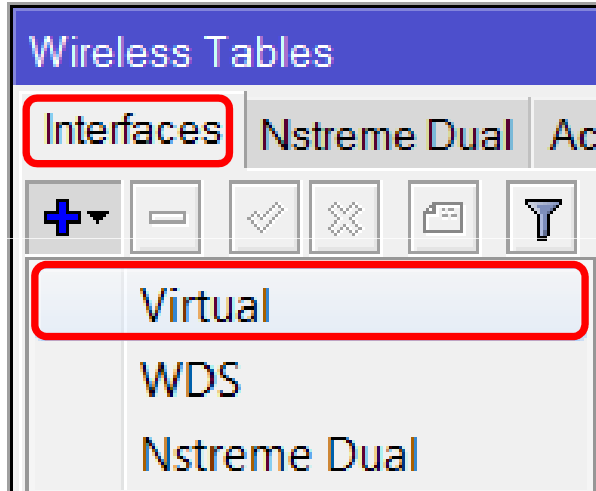

wlan2=virtual AP

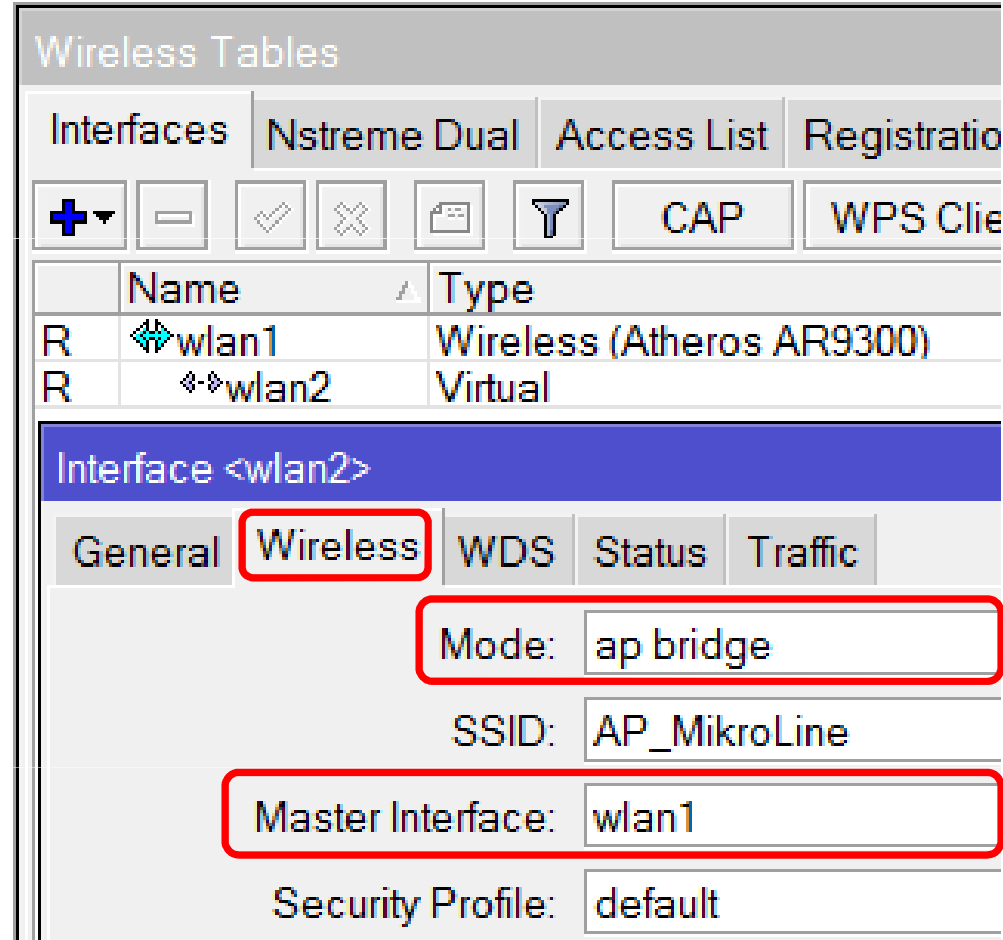

Setup wlan2 (virtual AP), as ap bridge to connect to clients.

Station & Virtual AP

Wireless Tables

Interfaces Nstreme Dual Access List **Registration** Connect List Security Profiles Channels

[-] [Filter] [Reset]

Radio Name ▾	MAC Address	Interface	Uptime	AP	WDS	Last Activity (s)	Tx/Rx Sign...
↕ radio ISP	4C:5E:0C:13:E6:7F	wlan1	02:30:10	yes	no	0.010	-56/-57
↕	00:27:10:7C:47:6C	wlan2	02:30:03	no	no	0.000	-51
↕	00:16:CE:72:B2:69	wlan2	02:18:58	no	no	2.470	-80
↕	00:25:86:C6:5B:B8	wlan2	01:53:24	no	no	0.080	-73
↕	30:75:12:38:C0:92	wlan2	01:34:38	no	no	0.090	-85
↕	24:71:7D:19:4F:1B	wlan2	01:26:36	no	no	6.380	-81
↕	C8:14:79:3B:51:92	wlan2	01:25:35	no	no	1.480	-70
↕	68:94:23:8A:C8:79	wlan2	01:13:40	no	no	0.040	-60
↕	00:08:22:20:1C:54	wlan2	01:09:37	no	no	2.590	-70
↕	CC:07:E4:26:28:D5	wlan2	01:04:37	no	no	0.100	-57
↕	80:A5:89:43:BF:41	wlan2	01:01:59	no	no	4.590	-69
↕	00:21:00:FC:AA:4C	wlan2	01:01:37	no	no	0.210	-83
↕	AC:D1:B8:F9:A3:...	wlan2	00:11:35	no	no	0.040	-56
↕	00:0A:00:A3:A1:62	wlan2	00:06:27	no	no	0.040	-73
↕	88:70:8C:28:F4:64	wlan2	00:00:54	no	no	5.180	-72
↕	26:99:35:2E:0A:D0	wlan2	00:00:29	no	no	0.270	-87

wlan1 = master interface/station (to ISP).

wlan2 = virtual interface/virtual AP (to clients).

AP & Virtual Station

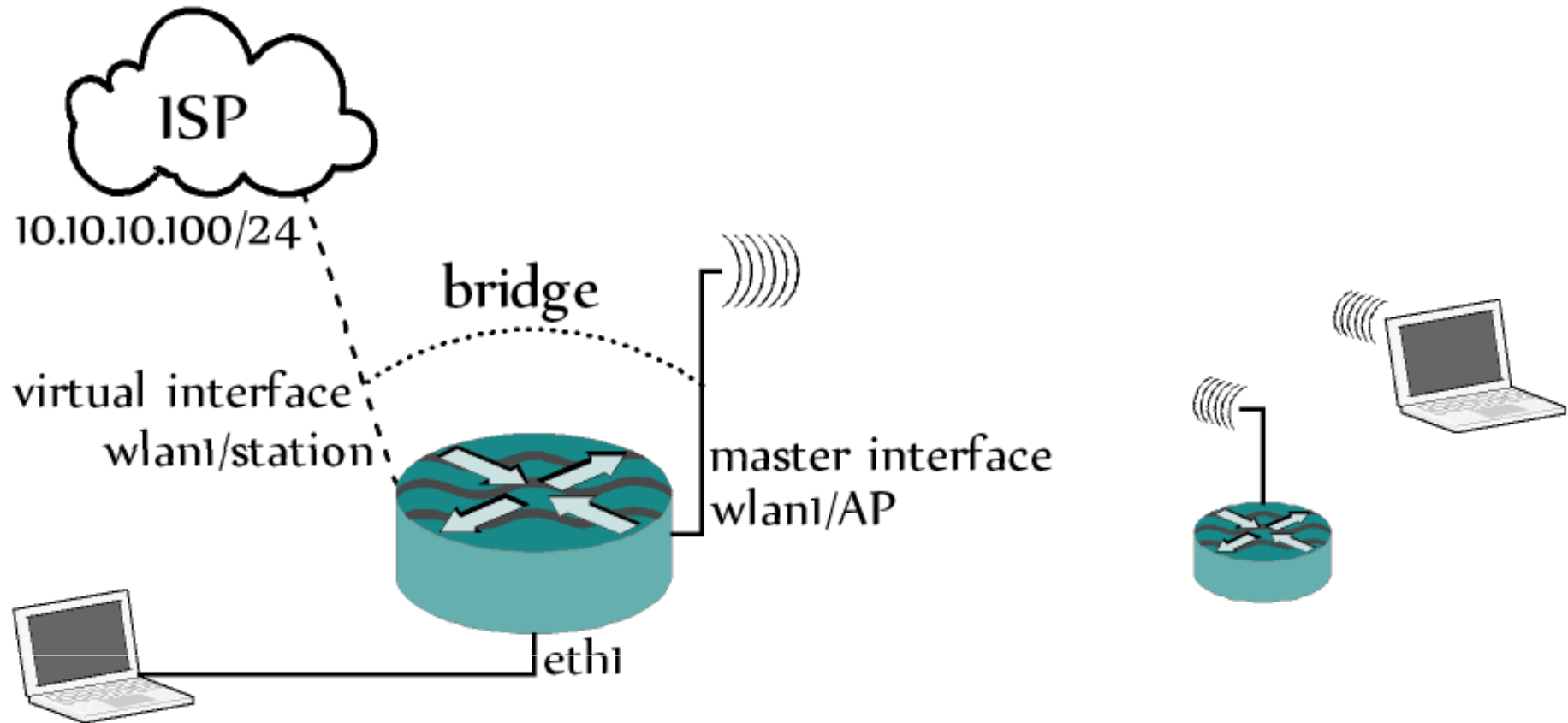

AP & Virtual Station

Wireless Tables

Interfaces Nstreme Dual Access List Regi

+ - ✓ ✗ [icon] CAP WP

Name	Type	T
wlan1	Wireless (Atheros AR9300)	

Interface <wlan1>

General Wireless HT HT MCS WDS

Mode: ap bridge

Band: 2GHz-B/G/N

Channel Width: 20MHz

Frequency: 2427

SSID: AP_MikroLine

Scan List: default

Setup wlan1 (master interface), as ap bridge to connect to clients.

Band, Channel Width and Frequency are also used in virtual station (wlan2).

AP & Virtual Station

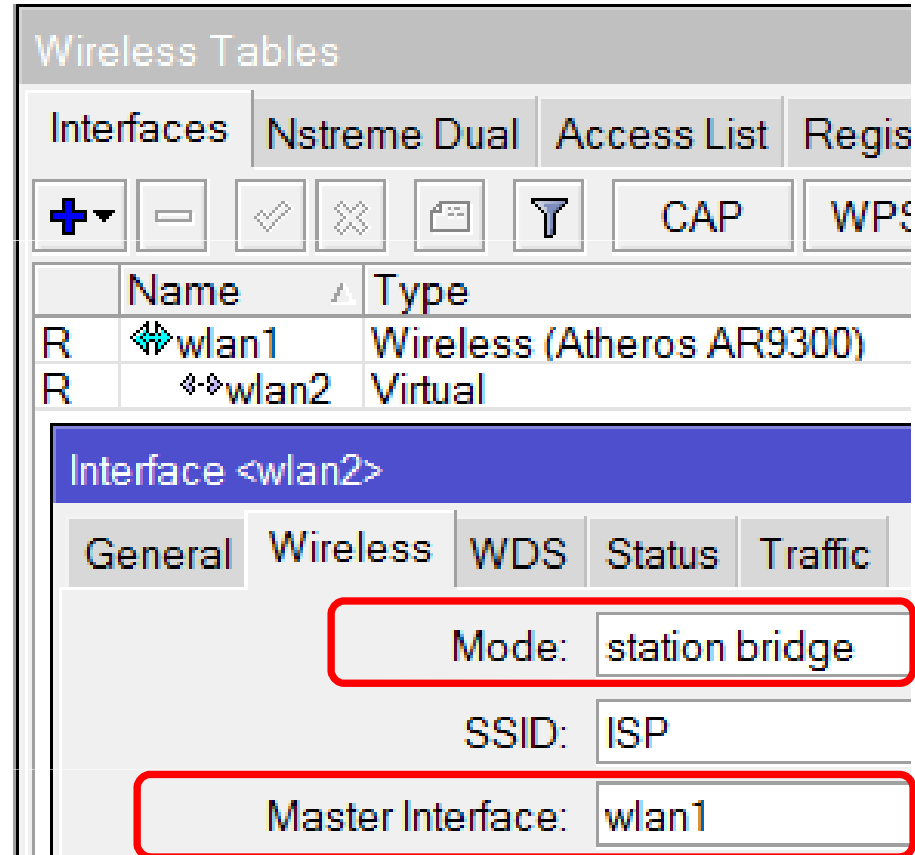
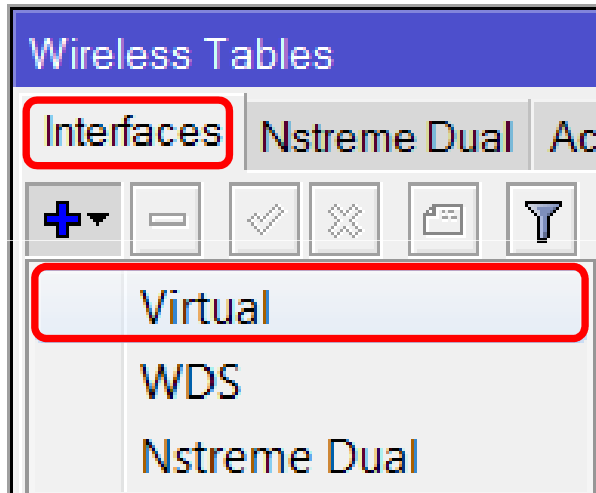

Setup wlan2 (virtual station), as station bridge to connect to ISP.

AP & Virtual Station

Wireless Tables

Interfaces Nstreme Dual Access List **Registration** Connect List Security Profiles Channels

[-] [Filter] [Reset]

Radio Name ▾	MAC Address	Interface	Uptime	AP	WDS	Last Activity (s)	Tx/Rx Sign..
↕ radio ISP	4C:5E:0C:13:E6:7F	wlan2	02:02:50	yes	no	0.040	-48/-48
↕	00:27:10:7C:47:6C	wlan1	02:02:51	no	no	0.000	-61
↕	00:25:86:C6:5B:B8	wlan1	02:02:51	no	no	0.000	-72
↕	AC:D1:B8:F9:A3:...	wlan1	02:02:32	no	no	0.380	-60
↕	88:70:8C:28:F4:64	wlan1	02:02:20	no	no	0.080	-71
↕	80:A5:89:43:BF:41	wlan1	02:02:10	no	no	0.370	-66
↕	00:16:CE:72:B2:69	wlan1	02:01:46	no	no	2.870	-81
↕	30:75:12:38:C0:92	wlan1	02:00:08	no	no	5.200	-87
↕	C8:14:79:3B:51:92	wlan1	01:58:42	no	no	0.150	-73
↕	64:6C:B2:3A:CB:...	wlan1	01:58:08	no	no	3.930	-83
↕	00:0A:00:A3:A1:62	wlan1	00:48:02	no	no	0.040	-82
↕	5C:93:A2:E1:A7:27	wlan1	00:35:59	no	no	1.670	-89
↕	CC:07:E4:26:28:D5	wlan1	00:30:01	no	no	0.330	-59
↕	24:F5:AA:74:89:3F	wlan1	00:14:44	no	no	0.320	-71
↕	54:27:1E:6A:85:B8	wlan1	00:14:26	no	no	0.200	-64
↕	2C:D0:5A:6D:90:...	wlan1	00:09:44	no	no	0.080	-79
↕	34:36:3B:9F:12:39	wlan1	00:00:22	no	no	3.710	-71

wlan1 = master interface/virtual AP (to clients).

wlan2 = virtual interface/station (to ISP).

WDS - Station WDS

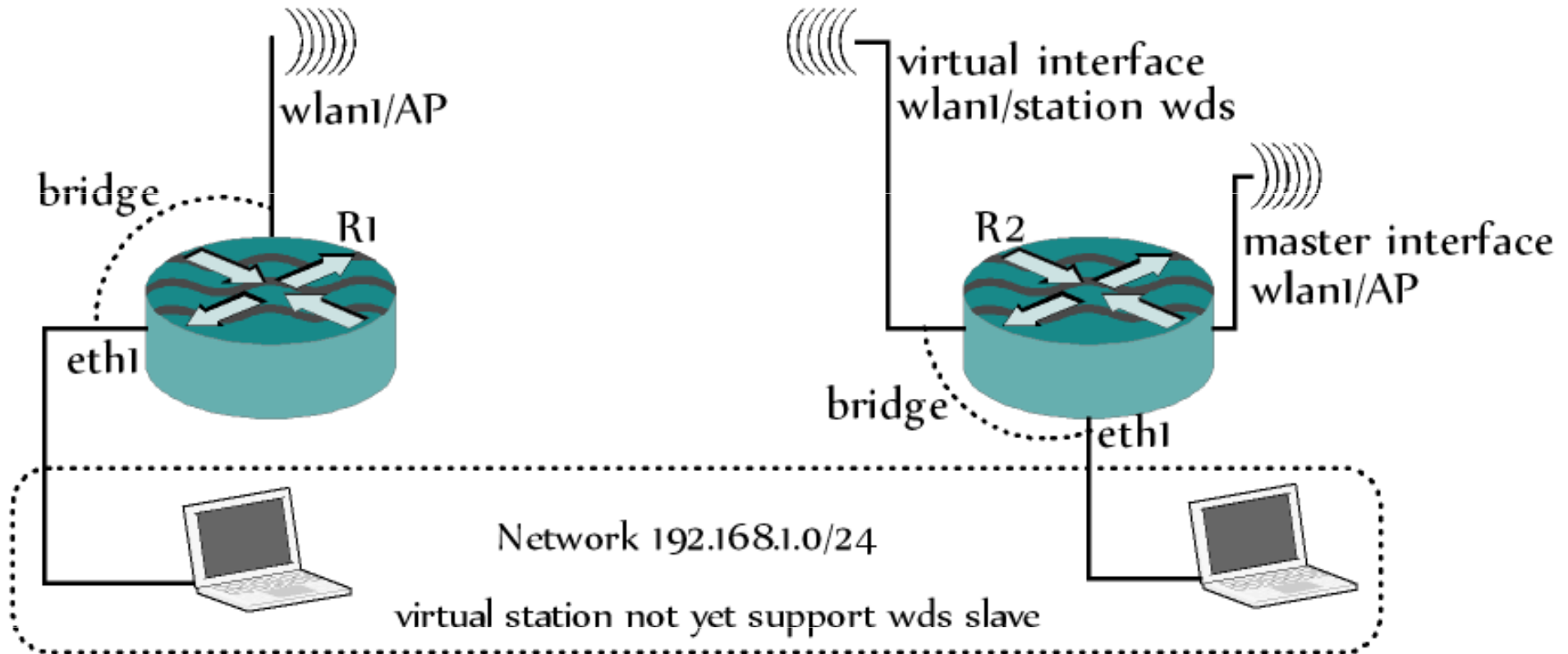

Wireless Tables				
Interfaces				
Name	Type	Mode	SSID	
RS wlan1	Wireless (Ath...	ap bridge	AP MikroLine	
DRSA wds2	WDS			

Wireless Tables				
Interfaces				
Name	Type	Mode	SSID	
R wlan1	Wireless (Ath...	ap bridge	AP MikroTik	
RS wlan2	Virtual	station wds	AP MikroLine	

wlan2=wlan1/virtual (station wds)

Thanks for attention

question ?