



MikroTik User Meeting in South Africa 2013

Keynote overview

1. About the MUM
2. Recently announced products
3. New products

MUM #48 is in South Africa!



MikroTik

- 100 employees
- Established in 1996
- RouterOS in 1997
- RouterBOARD in 2002
- First MUM Prague 2006
- Biggest MUM Indonesia 2012

Where is Latvia?



Staff

- Janis Jankovskis (Sales)
- Uldis Cernevskis (Support)
- Sergejs Boginskis (Support, Training)

5 Exhibitors



Special Thanks



At the MUM

- Wireless access **MUM** password **mikrotik**
- Lunch with vouchers at NCC room (next door)
- Distributor's hall
- Raffle at the end

After the MUM

- Presentation slides - wiki.mikrotik.com
- Presentation videos - tiktube.com
- License - will be sent by e-mail within few days

RECENTLY INTRODUCED

CCR 1036

- 36 core CPU
- 12 Gigabit Ethernet ports
- 4 SFP ports



CCR 1016

- 16 core CPU
- 12 Gigabit Ethernet ports



CCR EXTENDED RAM

- Same as CCR1036-12G-4S
- 16GB of RAM included



SFP MODULES

- Disruptive price (from \$22)
- Single or Multi mode
- 550m or 20Km
- DDM supported



CCR IMPROVEMENTS

- Software updated all the time
- Brings speed improvements for many features
- Simple Queues now 9x faster on CCR
- Hw encryption, L7, PPP and others in the works

SXT 5GHZ

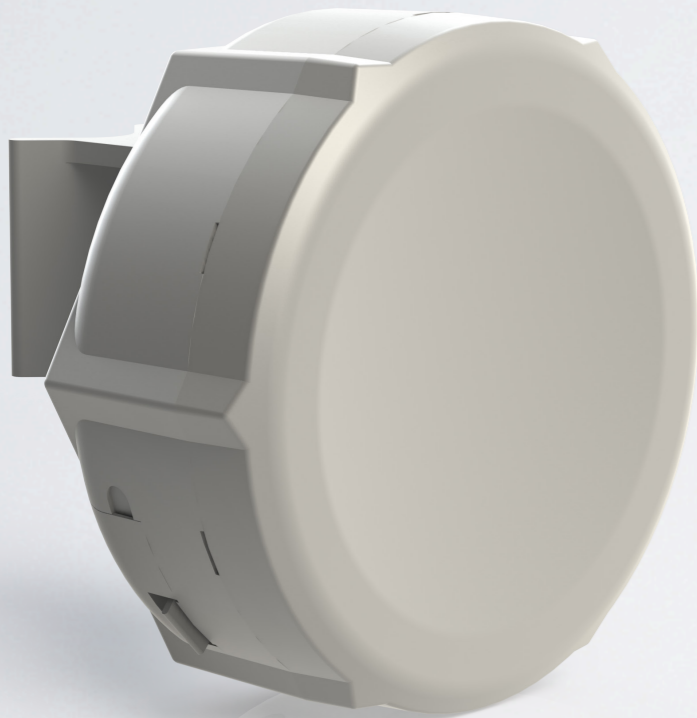

- High power model (30dBm, 5HPnD)
- “Lite” model (27dBm, Lite5)
- Both have new generation CPU

SXT 2GHZ

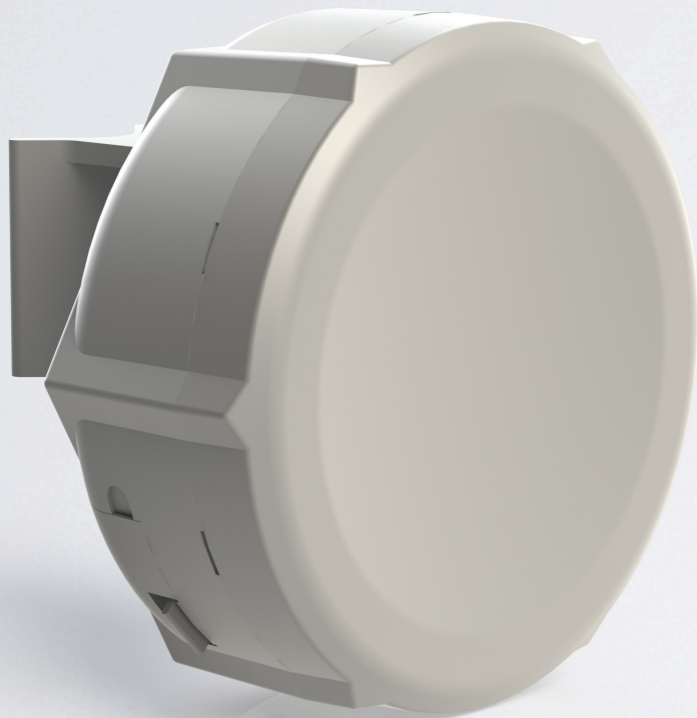

- High power Gigabit (32dBm, G-2HnD)
- “Lite” model (27dBm, Lite2)
- Both have new generation CPU

RB911G

- AR9xxx series CPU
- 2 or 5GHz models
- Gigabit ports, Dual Chain
- 30dBm (1000mW)

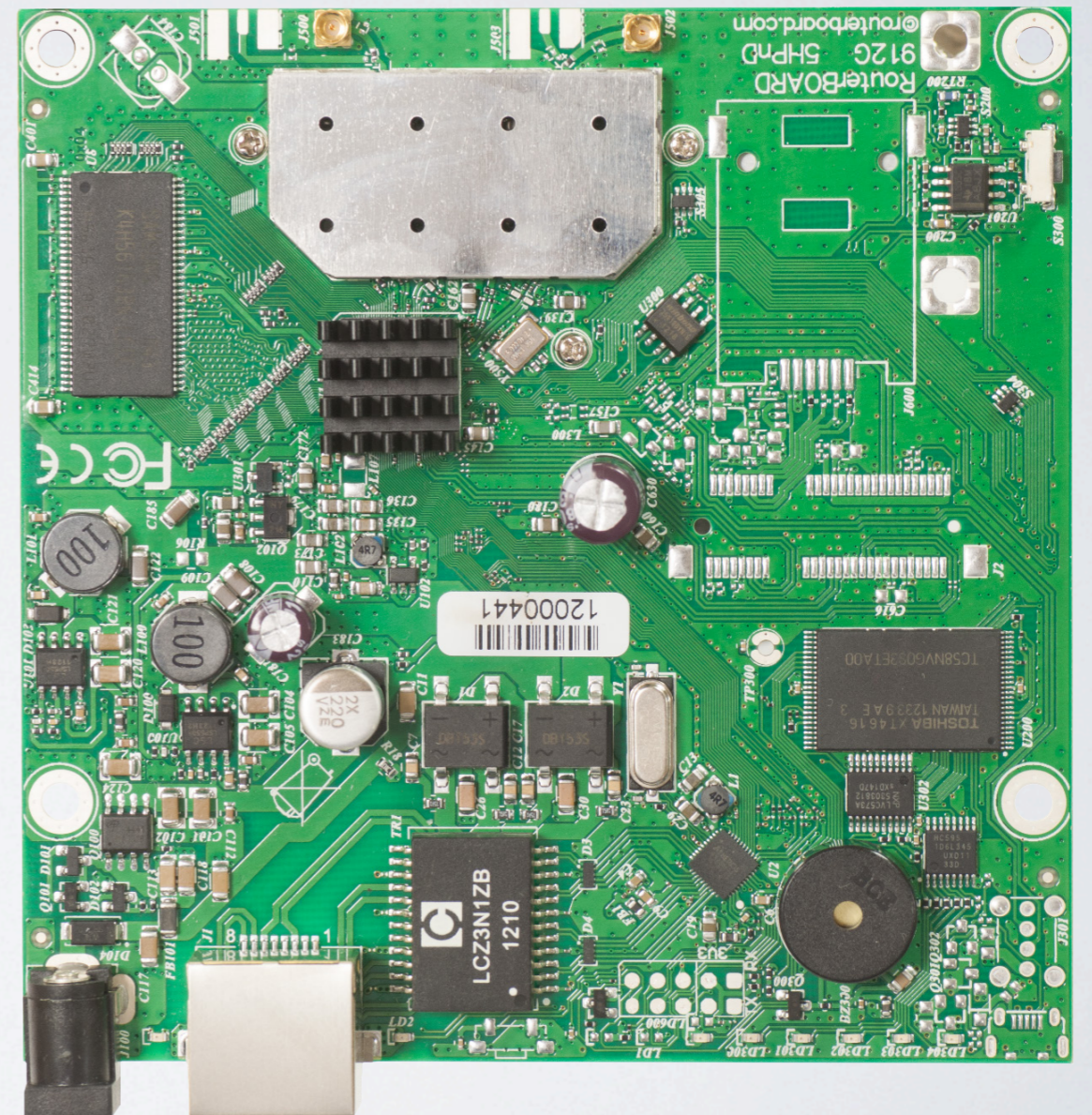

RB912G

- miniPCI-e slot
- USB, more RAM
- 2 or 5GHz models
- Can be used for Multiband AP

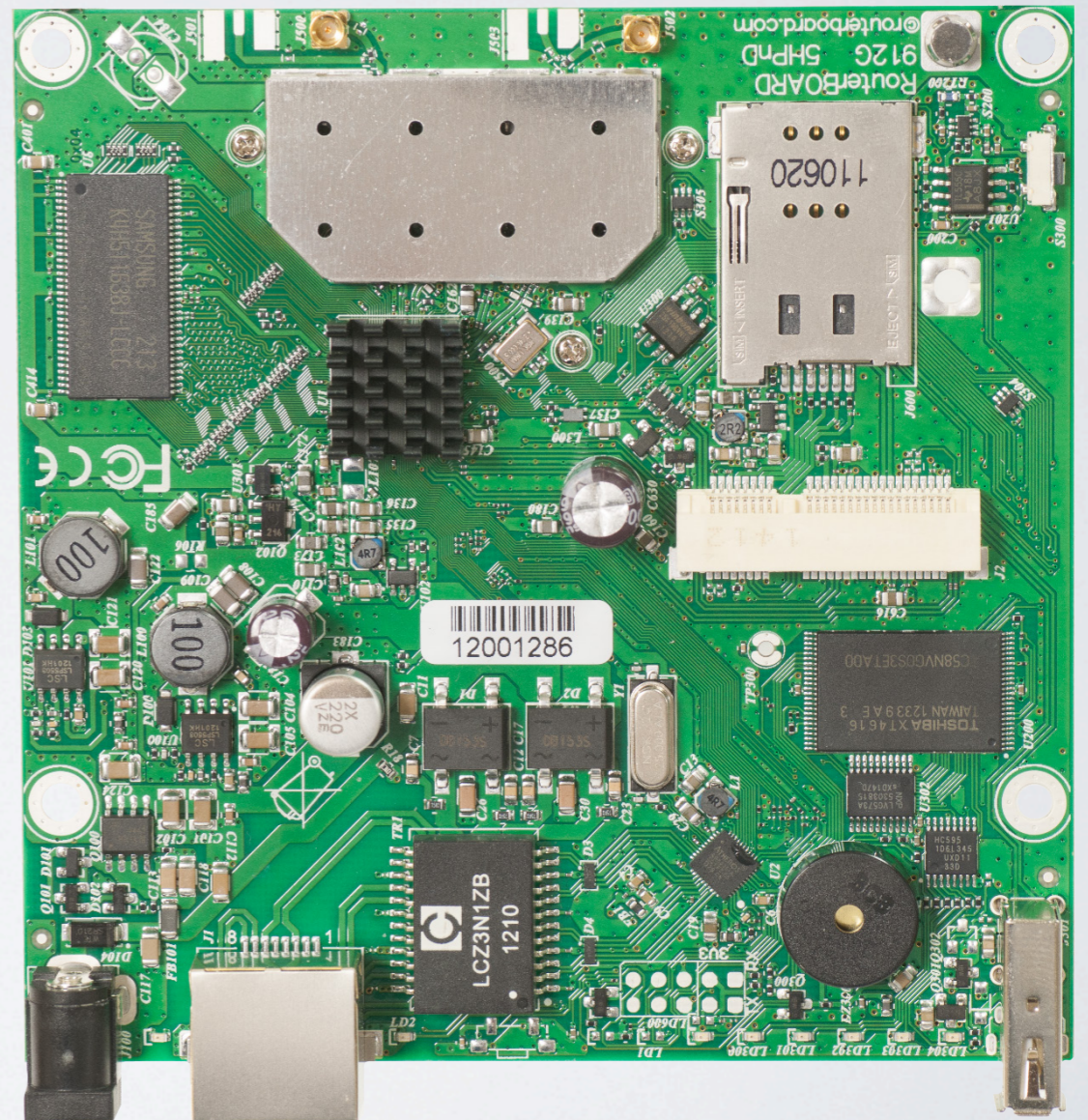

RB912G OUTDOOR



- SMA connectors
- Cable hood with rain protection
- Multiple mounting options
- 5GHz available
- 2GHz, August 2013



RB951UI

- SOHO AP
- 2.4 GHz, 1000mW
- 600MHz CPU, USB
- 5 port supports PoE-out



GROOVE 52

- Both bands built in
- Select 2 or 5Ghz
- AR9xxx CPU
- CPE or AP models available



NEW PRODUCTS

R11E-2HND

2013

SEP



- miniPCI-e to fit RB912
- 2GHz model
- 800mW power
- New AR9580 chipset
- uFl connectors

2013

SEP

RIIE-HPND

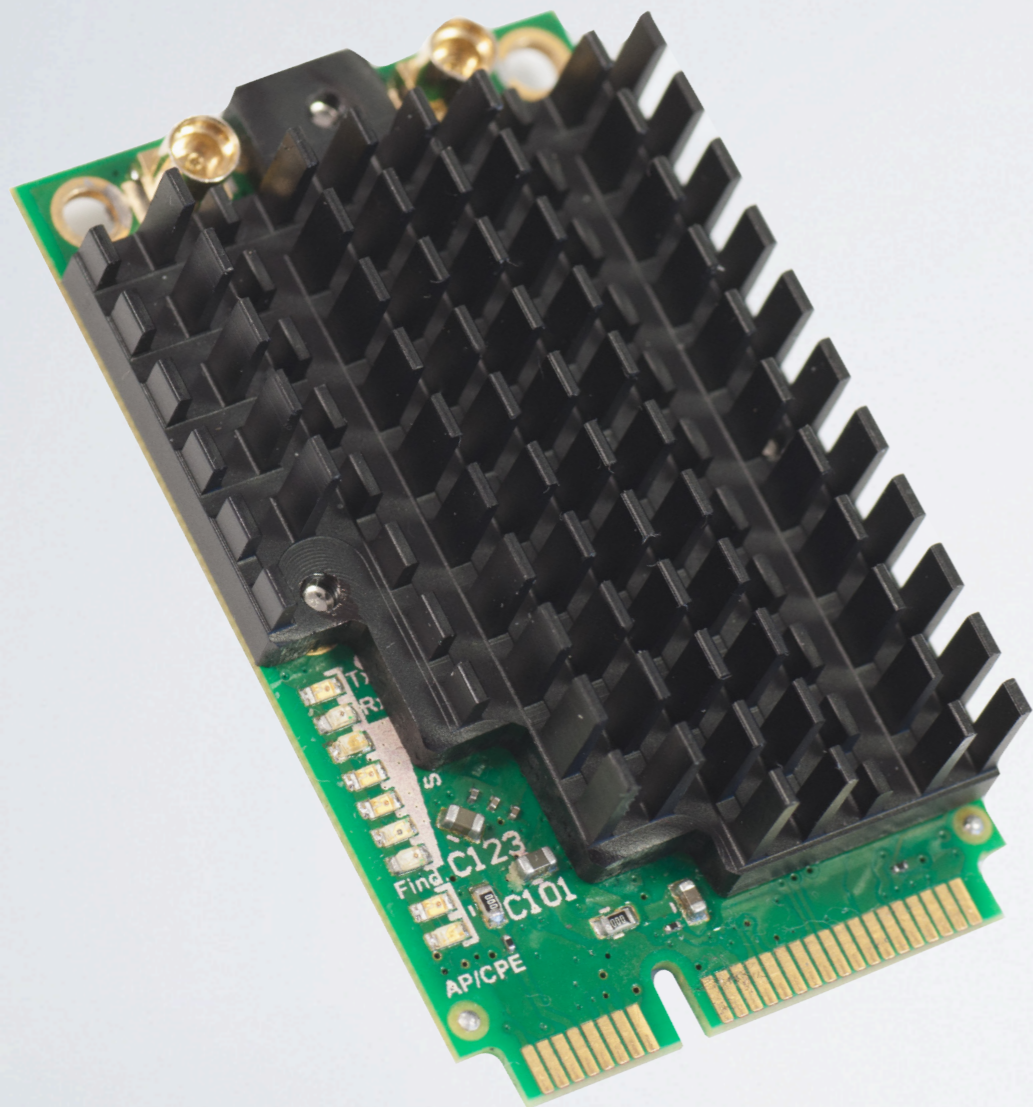

- miniPCI-e to fit RB912
- 2GHz and 5GHz models
- 1000mW power
- New AR9580 chipset
- MMCX

RB14EU

2013

AUG

- 4 miniPCle card adapter
- RB14E for wireless
- RB14EU also for 3G

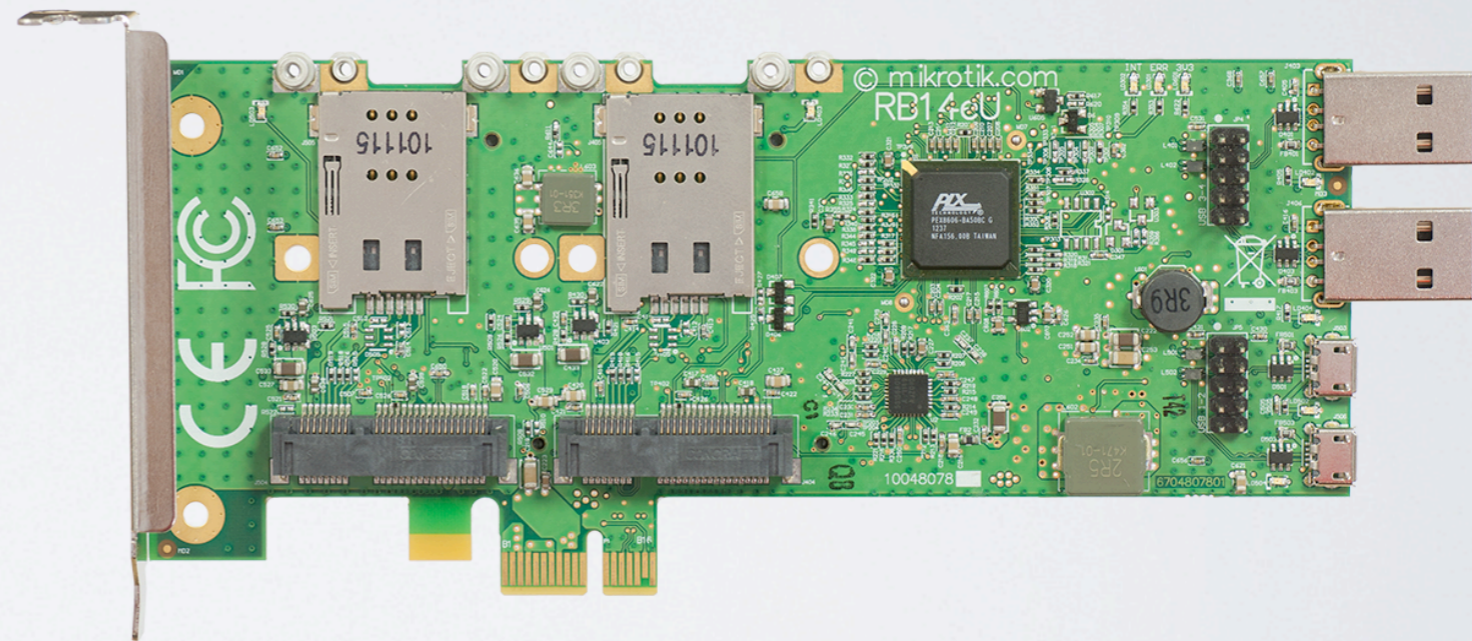

SXT HG

2013

SEP

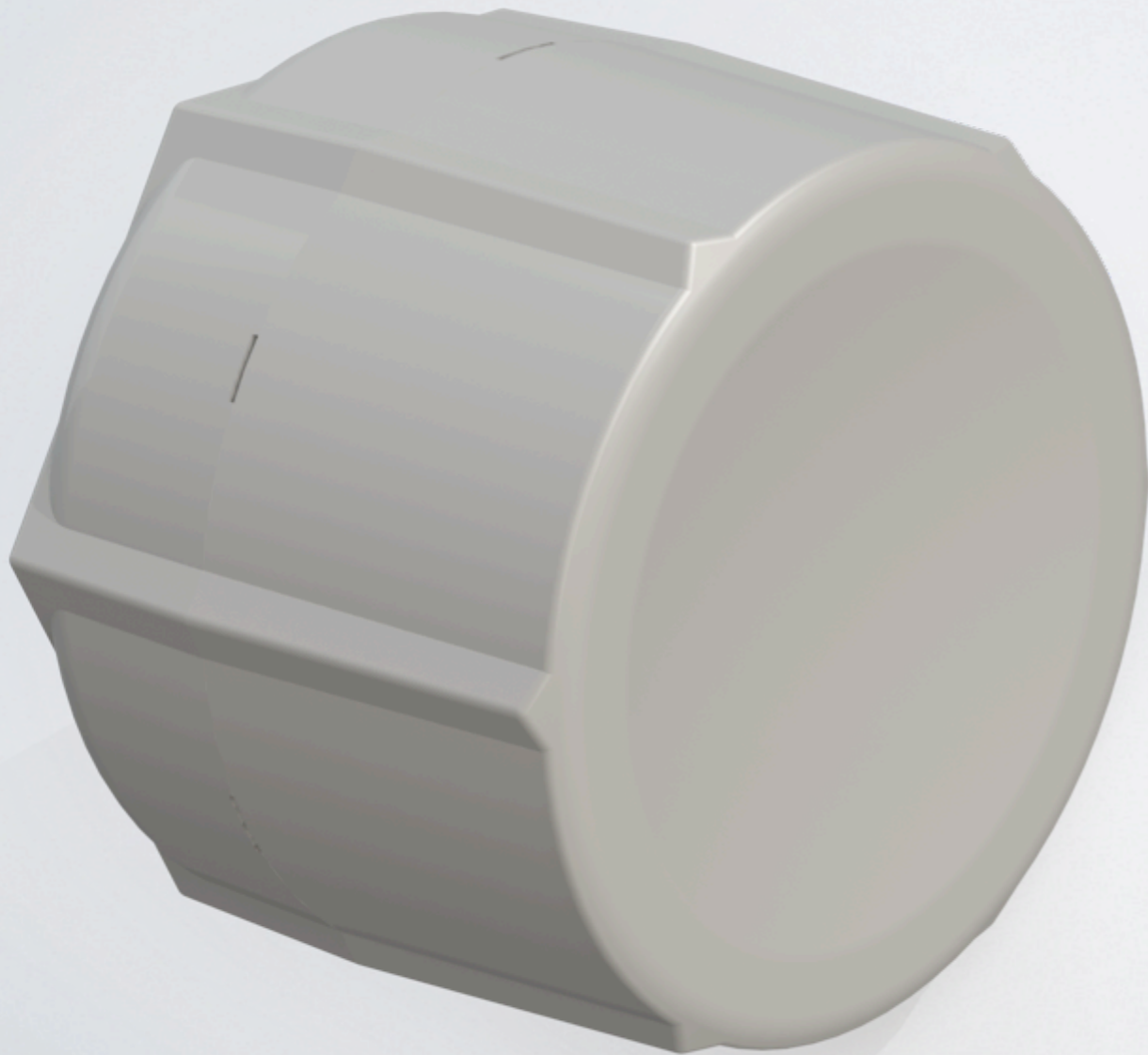

- Improved 17 dBi antenna
- New design
- 1000mW power
- Gigabit port
- 5GHz

2013

SEP

SXT SA

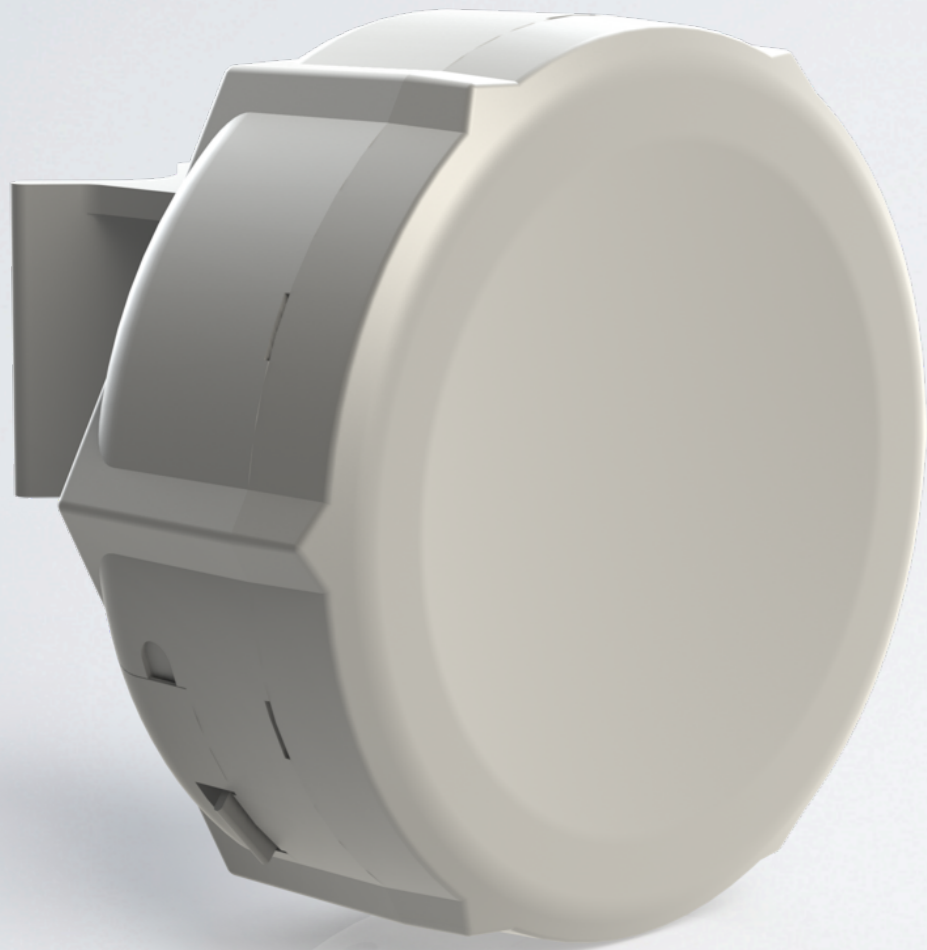

- Wide beamwidth, 90 degrees
- Can be used as Sector
- 1000mW power
- Gigabit port
- 5GHz

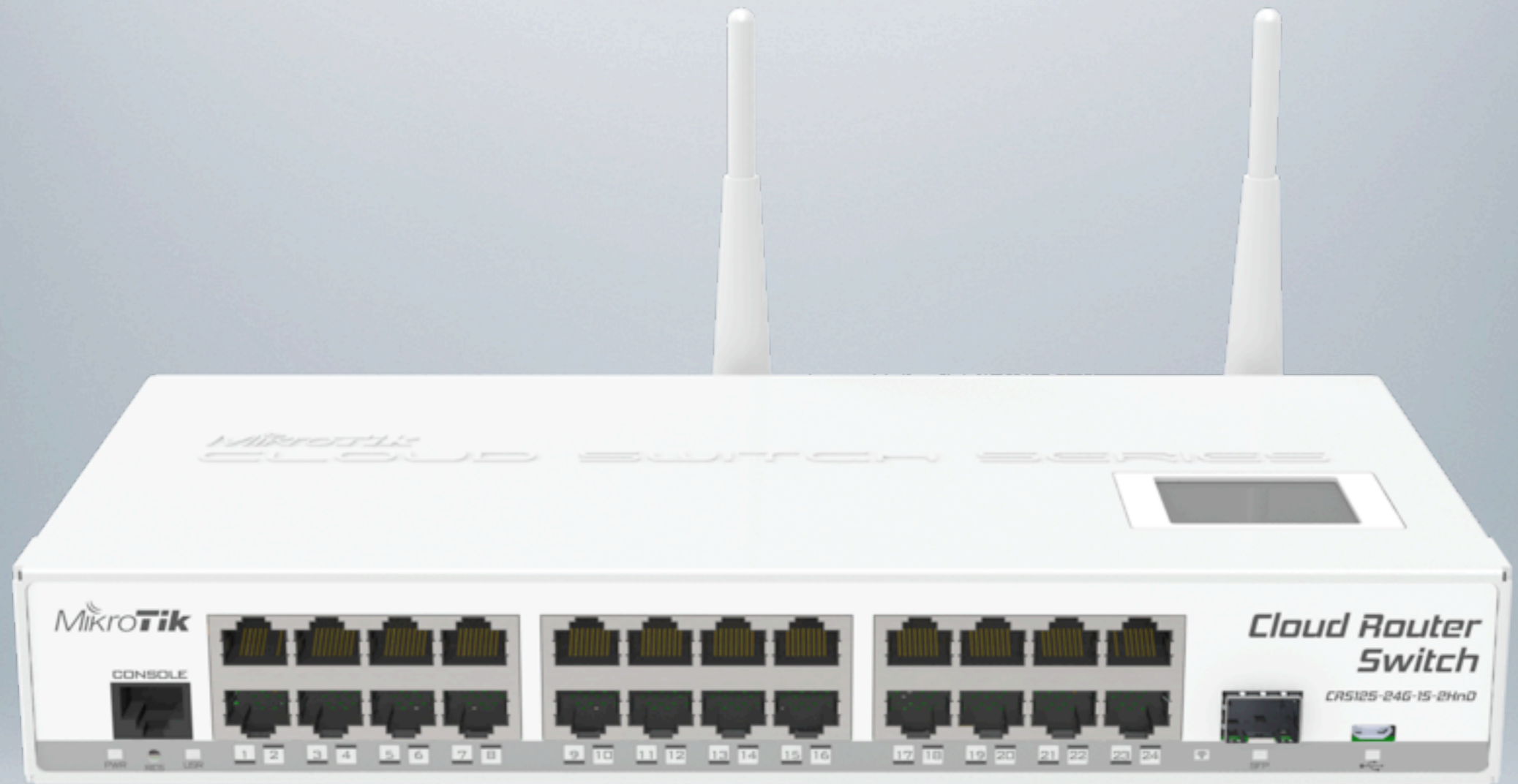

CLOUD ROUTER SWITCH

CRS

CRS



- 24 Switched Gigabit ports
- Powered by RouterOS
- SFP port
- Touchscreen LCD
- Wireless model available
- Comes in desktop or rackmount case
- Fully manageable smart switch

CRS I 25-24G IS-2HnD-IN	CRS I 25-24G IS-IN	CRS I 25-24G IS-RM
2Ghz wireless	-	-
Desktop case	Desktop case	Rackmount
SFP	SFP	SFP
24 Gigabit ports	24 Gigabit ports	24 Gigabit ports
RouterOS	RouterOS	RouterOS



CLOUD CORE ROUTER

SFP+

CCR1036-8G-2S+

2013

AUG

- 8 Gigabit Ethernet ports, **2 SFP+** ports
- **10G** interfaces now possible
- 16GB RAM model also available
- Highest performance MikroTik device ever
- Port speed no longer bottleneck, speed **2x**
- Total port speed **28Gbit**, which is new bottleneck
- Up to **42** million packets per second

Enjoy the MUM!

RouterOS v6
What is new?

RouterOS v6.x full release
is here

available on download page

Support for New Products

- Cloud Core Router, Cloud Router Switch and other new devices supported in RouterOS v6.x



New Linux Kernel

- RouterOS 5.25, Kernel version 2.6.35
- RouterOS 6.x, Kernel version 3.3.5+

New CPU architecture

- CCR devices
- 64-bit operating system (more RAM)
- Dual memory channel support
- Hardware Accelerated Multi-threading (no need for RPS and IRQ management)

The screenshot shows a 'Resources' window with the following data:

Uptime:	4d 22:25:40	OK
Free Memory:	9.2 GiB	PCI
Total Memory:	15.9 GiB	USB
CPU:	tilegx	CPU
CPU Count:	36	IRQ
CPU Frequency:	1200 MHz	
CPU Load:	0 %	
Free HDD Space:	902.8 MiB	
Total HDD Size:	1024.0 MiB	
Architecture Name:	tile	
Board Name:	CCR1036-12G-4S	
Version:	6.0	
Build Time:	May/17/2013 14:04:20	

New Features

- Newest interface driver support for x86
- Improved interface management, scales well for up to thousands interfaces
- Uses less space on storage - works well with 32MiB flash

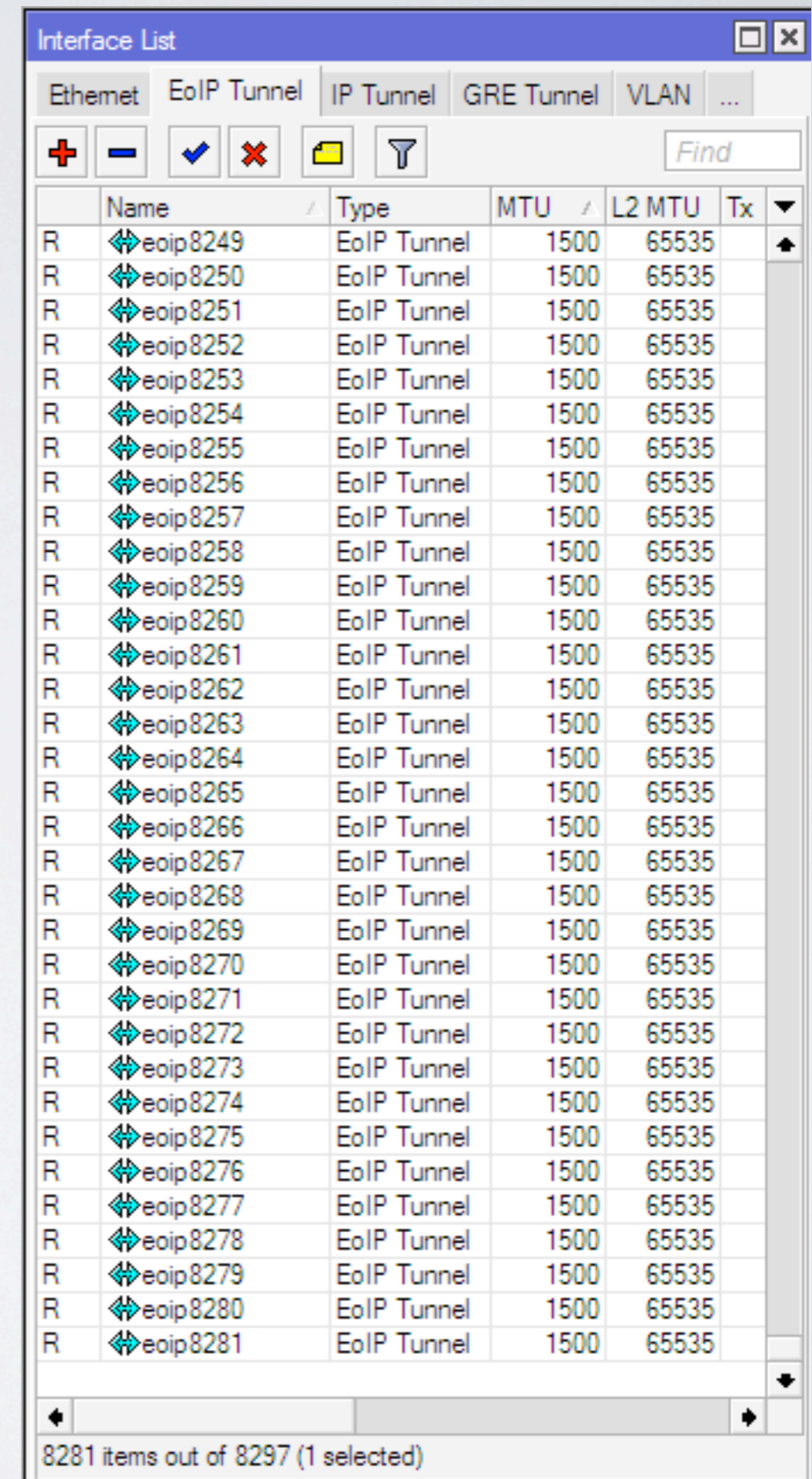

The screenshot shows a window titled "Interface List" with a tabbed interface. The "EoIP Tunnel" tab is selected. The window contains a table with the following columns: Name, Type, MTU, L2 MTU, and Tx. The table lists 20 EoIP Tunnel interfaces, each with a name starting with "eoiP" and a number from 8249 to 8281. The MTU for all is 1500 and the L2 MTU is 65535. The status "R" is shown in the first column of each row. At the bottom of the window, it says "8281 items out of 8297 (1 selected)".

	Name	Type	MTU	L2 MTU	Tx
R	eoiP8249	EoIP Tunnel	1500	65535	
R	eoiP8250	EoIP Tunnel	1500	65535	
R	eoiP8251	EoIP Tunnel	1500	65535	
R	eoiP8252	EoIP Tunnel	1500	65535	
R	eoiP8253	EoIP Tunnel	1500	65535	
R	eoiP8254	EoIP Tunnel	1500	65535	
R	eoiP8255	EoIP Tunnel	1500	65535	
R	eoiP8256	EoIP Tunnel	1500	65535	
R	eoiP8257	EoIP Tunnel	1500	65535	
R	eoiP8258	EoIP Tunnel	1500	65535	
R	eoiP8259	EoIP Tunnel	1500	65535	
R	eoiP8260	EoIP Tunnel	1500	65535	
R	eoiP8261	EoIP Tunnel	1500	65535	
R	eoiP8262	EoIP Tunnel	1500	65535	
R	eoiP8263	EoIP Tunnel	1500	65535	
R	eoiP8264	EoIP Tunnel	1500	65535	
R	eoiP8265	EoIP Tunnel	1500	65535	
R	eoiP8266	EoIP Tunnel	1500	65535	
R	eoiP8267	EoIP Tunnel	1500	65535	
R	eoiP8268	EoIP Tunnel	1500	65535	
R	eoiP8269	EoIP Tunnel	1500	65535	
R	eoiP8270	EoIP Tunnel	1500	65535	
R	eoiP8271	EoIP Tunnel	1500	65535	
R	eoiP8272	EoIP Tunnel	1500	65535	
R	eoiP8273	EoIP Tunnel	1500	65535	
R	eoiP8274	EoIP Tunnel	1500	65535	
R	eoiP8275	EoIP Tunnel	1500	65535	
R	eoiP8276	EoIP Tunnel	1500	65535	
R	eoiP8277	EoIP Tunnel	1500	65535	
R	eoiP8278	EoIP Tunnel	1500	65535	
R	eoiP8279	EoIP Tunnel	1500	65535	
R	eoiP8280	EoIP Tunnel	1500	65535	
R	eoiP8281	EoIP Tunnel	1500	65535	

What else?

- 64 CPU core support
- Improved RouterOS performance on multi-cpu systems (20%)
- Improved RouterBOARD interface driver performance (30%)
- RouterBOARD package is now merged into system

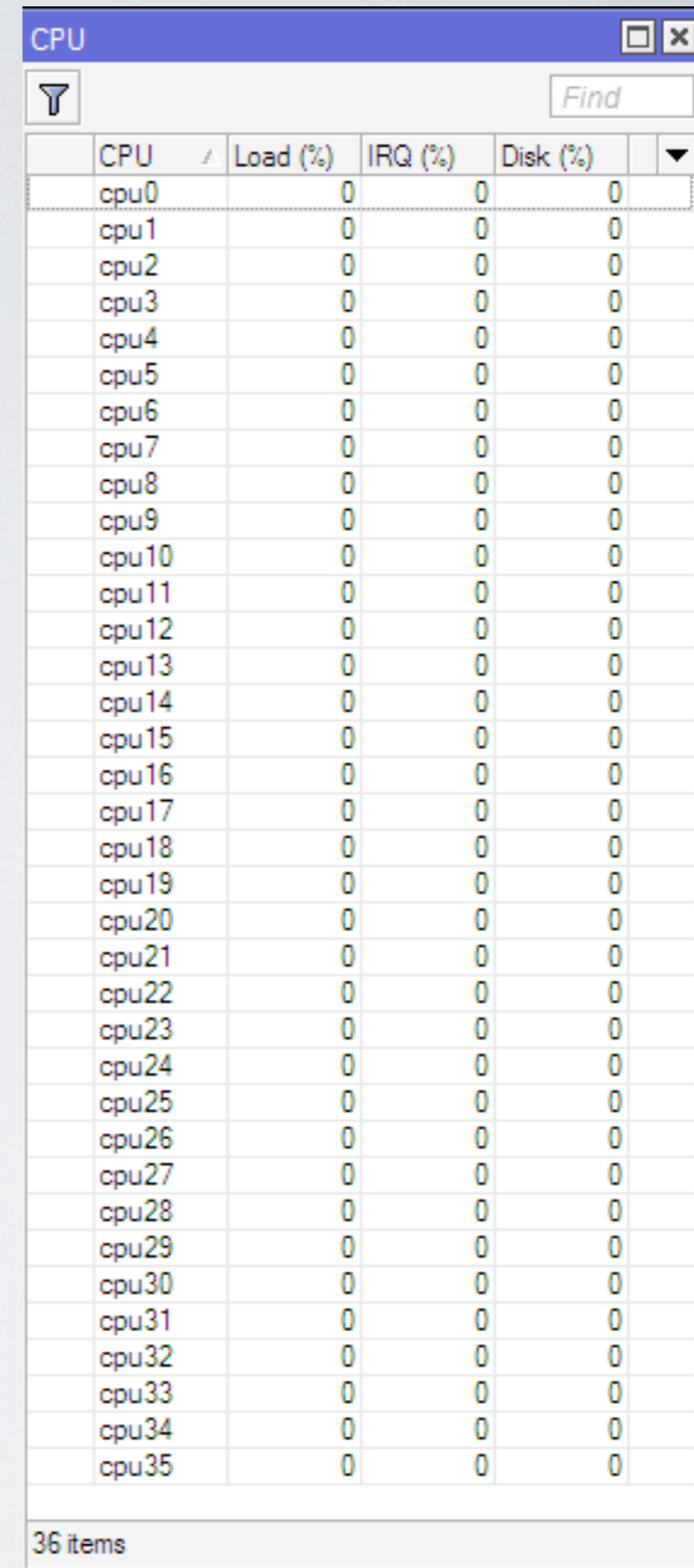

The screenshot shows a window titled "CPU" with a search bar and a table of CPU statistics. The table has columns for CPU, Load (%), IRQ (%), and Disk (%). All values are 0. The window also shows "36 items" at the bottom.

CPU	Load (%)	IRQ (%)	Disk (%)
cpu0	0	0	0
cpu1	0	0	0
cpu2	0	0	0
cpu3	0	0	0
cpu4	0	0	0
cpu5	0	0	0
cpu6	0	0	0
cpu7	0	0	0
cpu8	0	0	0
cpu9	0	0	0
cpu10	0	0	0
cpu11	0	0	0
cpu12	0	0	0
cpu13	0	0	0
cpu14	0	0	0
cpu15	0	0	0
cpu16	0	0	0
cpu17	0	0	0
cpu18	0	0	0
cpu19	0	0	0
cpu20	0	0	0
cpu21	0	0	0
cpu22	0	0	0
cpu23	0	0	0
cpu24	0	0	0
cpu25	0	0	0
cpu26	0	0	0
cpu27	0	0	0
cpu28	0	0	0
cpu29	0	0	0
cpu30	0	0	0
cpu31	0	0	0
cpu32	0	0	0
cpu33	0	0	0
cpu34	0	0	0
cpu35	0	0	0

36 items

Fast Path

- Forwards packets without additional processing in the Kernel
- Requires allowance in configuration, interface driver support and specific configuration conditions
- Improved RouterBOARD interface driver performance (30%)
- Current handlers, ipv4, traffic generator, mpls, bridge
- More handlers in the future.

New Test results

RB951G-2HnD		Gigabit Ethernet test (600Mhz)		RouterOS v6.0rc5				
Mode	Configuration	64 byte		512 byte		1518 byte		
		kpps	Mbps	kpps	Mbps	kpps	Mbps	
Bridging	none (fast path)	269.6	176.9	232	983.7	81	995.3	
Bridging	25 Bridge filter rules	87.6	57.5	86	364.6	81	995.3	
Routing	none (fast path)	226.9	148.8	210	890.4	81	995.3	
Routing	RB1100Hx2				RouterOS v6.			
Routing	Mode	Configuration	64 byte		512 byte		1518 byte	
			kpps	Mbps	kpps	Mbps	kpps	Mbps
	Bridging	none (fast path)	1690	1108.6	704	2985.0	406	4988.9
	Bridging	25 Bridge filter rules	412	270.3	396	1679.0	308	3784.7
	Routing	none (fast path)	1495	980.7	704	2985.0	345	4239.4
Routing	CCR1036-12G-4S				RouterOS v6.			
Routing	Mode	Configuration	64 byte		512 byte		1518 byte	
			kpps	Mbps	kpps	Mbps	kpps	Mbps
	Bridging	none (fast path)	23808	15618.0	3759	15938.2	1300	15974.4
	Bridging	25 Bridge filter rules	7340	4815.0	3759	15938.2	1300	15974.4
	Routing	none (fast path)	23808	15618.0	3759	15938.2	1300	15974.4
	Routing	25 Simple Queues	7919	5194.9	3759	15938.2	1300	15974.4
	Routing	25 IP filter rules	3127	2051.3	2998	12711.5	1300	15974.4

Test results

Interface List								
Interface	Ethernet	EoIP Tunnel	IP Tunnel	GRE Tunnel	VLAN	VRRP	Bonding	LTE
Name	Type	MTU	L2 MTU	Tx	Rx	Tx Packet...	Rx Packet (...)	
RS ether1	Ethernet	1500	1590	478.5 Mbps	465.8 Mbps	996 885	970 618	
RS ether2	Ethernet	1500	1590	477.2 Mbps	480.3 Mbps	994 356	1 000 701	
RS ether3	Ethernet	1500	1590	475.1 Mbps	513.4 Mbps	989 969	1 069 736	
RS ether4	Ethernet	1500	1590	476.6 Mbps	492.0 Mbps	993 024	1 025 024	
RS ether5	Ethernet	1500	1590	475.8 Mbps	501.4 Mbps	991 399	1 044 710	
RS ether6	Ethernet	1500	1590	478.4 Mbps	469.2 Mbps	996 816	977 502	
RS ether7	Ethernet	1500	1590	478.1 Mbps	471.7 Mbps	996 120	982 714	
RS ether8	Ethernet	1500	1590	482.7 Mbps	408.8 Mbps	1 005 632	851 693	
RS ether9	Ethernet	1500	1590	477.1 Mbps	487.0 Mbps	994 065	1 014 717	
RS ether10	Ethernet	1500	1590	478.2 Mbps	468.2 Mbps	996 343	975 495	
RS ether11	Ethernet	1500	1590	479.2 Mbps	455.3 Mbps	998 539	948 640	
R ether12	Ethernet	1500	1590	239.1 kbps	3.8 kbps	20	8	
RS sfp1	Ethernet	1500	1590	477.9 Mbps	473.4 Mbps	995 799	986 300	
RS sfp2	Ethernet	1500	1590	478.5 Mbps	462.1 Mbps	997 057	962 716	
RS sfp3	Ethernet	1500	1590	474.9 Mbps	515.6 Mbps	989 467	1 074 223	
RS sfp4	Ethernet	1500	1590	476.1 Mbps	500.4 Mbps	992 005	1 042 681	

16 items out of 17

```
[admin@RouterOS] > interface monitor-traffic aggregate
rx-packets-per-second: 15 577 081
rx-drops-per-second: 0
rx-errors-per-second: 0
rx-bits-per-second: 7.4Gbps
tx-packets-per-second: 15 576 803
tx-drops-per-second: 0
tx-errors-per-second: 0
tx-bits-per-second: 7.4Gbps
- [Q quit|D dump|C-z pause]
```

QoS changes at v6.x

- Warning!!

Simple queue and Queue Tree in some specific configurations might be inactivated after upgrade from 3.x, 4.x, 5.x to 6.x

Automatic configuration transition is not available, as it might cause inability to access a router.

Changes in Packet Flow

- Queuing in different place caused enormous performance degradation
- At v6.x queueing happens in the same place
- Global-in, global-out and global-total are replaced by global
- It occurs at the very end of packet's "life-cycle" in a router

HTTB in RouterOS v5

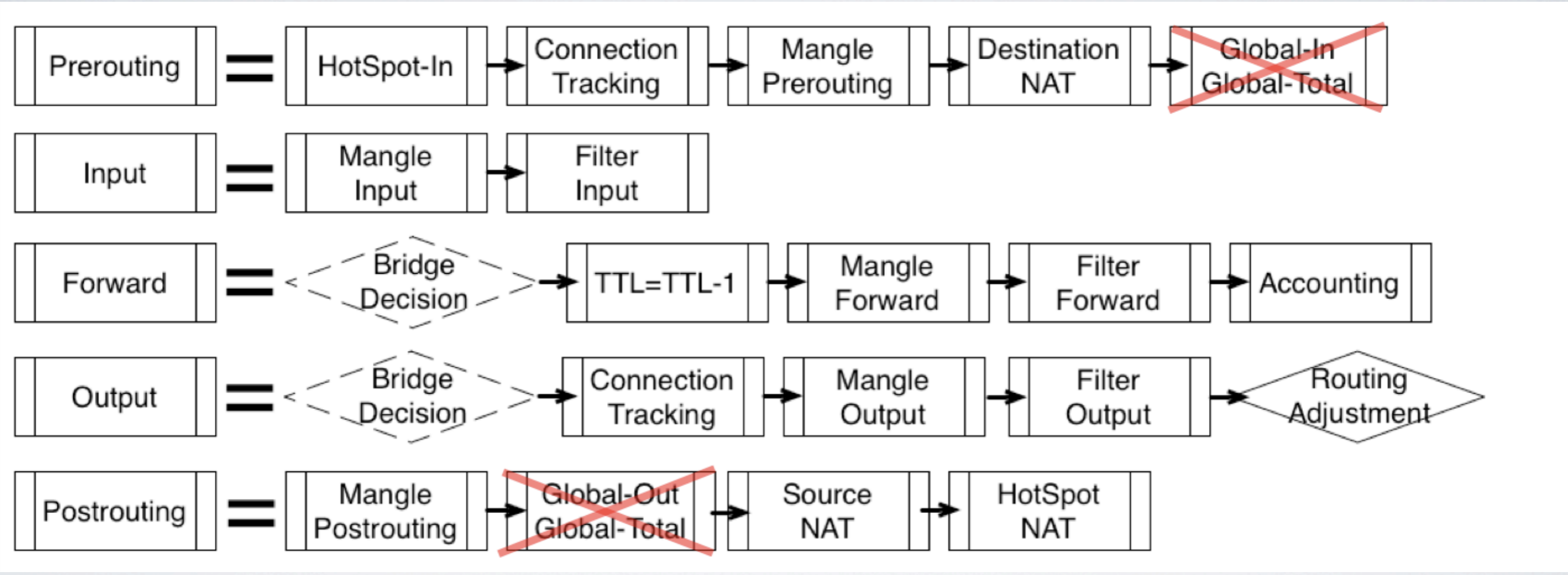

HTB in RouterOS v6

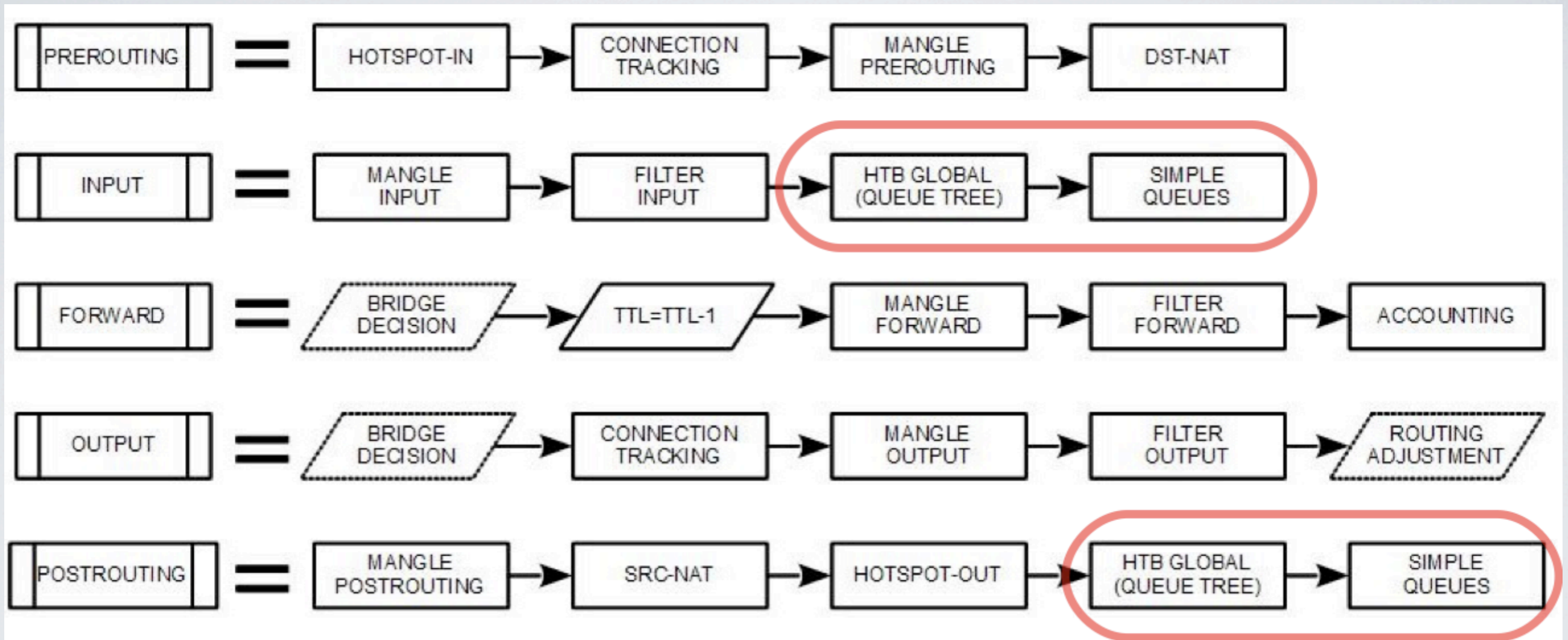

More changes

- Simple queues are not separated from Queue tree completely
- Queuing happens after SRC-NAT, PCQ queue is now NAT aware
- Multiple packet-marks per single queue

Simple Queues

- Simple queue matching algorithm updated
- Small overhead for packets that miss existing simple queues
- Top level simple queues are now balanced between CPU cores

Queue List

Simple Queues | Interface Queues | Queue Tree | Queue Types

+ - ✓ ✕ 📄 🔍 ☰ Reset Counters ∞ Reset A

#	Name	Target	Rx Max Limit	Tx Max Limit
24967	queue24968	4.4.100.218	1M	1M
24968	queue24969	4.4.100.219	1M	1M
24969	queue24970	4.4.100.220	1M	1M
24970	queue24971	4.4.100.221	1M	1M
24971	queue24972	4.4.100.222	1M	1M
24972	queue24973	4.4.100.223	1M	1M
24973	queue24974	4.4.100.224	1M	1M
24974	queue24975	4.4.100.225	1M	1M
24975	queue24976	4.4.100.226	1M	1M
24976	queue24977	4.4.100.227	1M	1M
24977	queue24978	4.4.100.228	1M	1M
24978	queue24979	4.4.100.229	1M	1M
24979	queue24980	4.4.100.230	1M	1M
24980	queue24981	4.4.100.231	1M	1M
24981	queue24982	4.4.100.232	1M	1M
24982	queue24983	4.4.100.233	1M	1M
24983	queue24984	4.4.100.234	1M	1M
24984	queue24985	4.4.100.235	1M	1M
24985	queue24986	4.4.100.236	1M	1M
24986	queue24987	4.4.100.237	1M	1M
24987	queue24988	4.4.100.238	1M	1M
24988	queue24989	4.4.100.239	1M	1M
24989	queue24990	4.4.100.240	1M	1M
24990	queue24991	4.4.100.241	1M	1M
24991	queue24992	4.4.100.242	1M	1M
24992	queue24993	4.4.100.243	1M	1M
24993	queue24994	4.4.100.244	1M	1M
24994	queue24995	4.4.100.245	1M	1M
24995	queue24996	4.4.100.246	1M	1M
24996	queue24997	4.4.100.247	1M	1M
24997	queue24998	4.4.100.248	1M	1M
24998	queue24999	4.4.100.249	1M	1M
24999	queue25000	4.4.100.250	1M	1M

25000 items | 0 B queued | 0 packets queued

Simple Queues

- “target-address” and “interface” are joined to “target”
- “dst-address” changes to “dst” and supports interfaces
- direction and p2p parameters removed
- “target” must be specified on simple queue
- Separate “priority” for download, upload and total

Simple Queue v5

New Simple Queue

General | Advanced | Statistics | Traffic | Total | Total Statistics

Name:

Target Address:

Target Upload Target Download

Max Limit: bits/s bits/s

Burst

Burst Limit: bits/s bits/s

Burst Threshold: bits/s bits/s

Burst Time: s s

Time

Time: -

sun mon tue wed thu fri sat

enabled

New Simple Queue

General | Advanced | Statistics | Traffic | Total | Total Statistics

P2P:

Packet Marks:

Dst. Address:

Interface:

Target Upload Target Download

Limit At: bits/s bits/s

Queue Type:

Parent:

Priority:

OK

Cancel

Apply

Disable

Comment

Copy

Remove

Reset Counters

Reset All Counters

Torch

enabled

Simple Queue v6

The image displays two side-by-side screenshots of the Mikrotik WinBox 'New Simple Queue' configuration window. The left window is in the 'General' tab, and the right window is in the 'Advanced' tab. Both windows show various settings for upload and download limits, burst, and time. Red boxes highlight specific fields in both windows.

Left Window (General Tab):

- Name: queue_from_v6
- Target: 192.168.1.254
- Dst.: ether7
- Max Limit: 20M (Upload), 20M (Download) bits/s
- Burst Limit: unlimited (Upload), unlimited (Download) bits/s
- Burst Threshold: unlimited (Upload), unlimited (Download) bits/s
- Burst Time: 0 (Upload), 0 (Download) s
- Time: 00:00:00 - 1d 00:00:00
- Days: sun, mon, tue, wed, thu, fri, sat
- enabled

Right Window (Advanced Tab):

- Packet Marks: (empty)
- Limit At: 2M (Upload), 2M (Download) bits/s
- Priority: 6 (Upload), 7 (Download)
- Queue Type: pcq-upload-default (Upload), pcq-download-default (Download)
- Parent: none
- OK, Cancel, Apply, Disable, Comment, Copy, Remove, Reset Counters, Reset All Counters, Torch
- enabled

Firewall changes

- “all-ether”, “all-wireless”, “all-vlan”, “all-ppp” for interface matching
- Priority matcher
- New “change-dscp” options
- Mangle actions to send packet stream to remote sniffer

Tunnel changes

- SSTP can now force AES encryption
- PPP profile has “bridge-past-cost” and “bridge-port-priority”
- PPP secrets shows last-logged-out date and time
- HotSpot and PPP supports multiple address-lists from RADIUS
- Only 2 dynamic “change-mss” are created for “all-ppp” interfaces

DHCP changes

- dhcp-options can be specified by mixing different data types
- dhcp-client have custom dhcp-option feature
- DHCP v4 now have special classless option for add-default-route parameter
- Possibility to add DHCP relay agent information option (Option 82)
- DHCPv6 DNS option support

Other changes

- /export compact is now default for /export
- Connected routes become inactive when interface goes down
- Configurable Kernel options in /ip settings and /ipv6 settings menus
- IPSec road warrior support
- SCEP protocol support
- Initial OpenFlow support

Thank you!